

TOSHIBA

6F8A0770

ELECTROMAGNETIC FLOWMETER

MODEL LF434 / LF404

INSTRUCTION MANUAL

TOSHIBA CORPORATION

NOTICE

This Manual is designed to assist in installing, operating, and maintaining the LF434/LF404 electromagnetic flowmeter. For safety reasons, and to obtain the optimum performance from the flowmeter, read this Manual thoroughly before working with the product. Keep the Manual within easy reach for reference whenever needed.

The flowmeter to which this Manual refers is **NOT** designed for applications in which the functioning of this product is critical to human safety, such as:

- Main control systems of nuclear power plants; safety systems in nuclear facilities or other critical control lines directly affecting human safety.
- Control systems of medical equipment, including life support machines.

NOTES

1. The reproduction of the contents of this Manual in any form, whether wholly or in part, is not permitted without explicit prior consent and approval.
2. The information contained in this Manual is subject to change or review without prior notice.
3. Be sure to follow all safety, operating and handling precautions described in this Manual and the regulations in force in the country in which this product is to be used.

HART is a registered trademark of the HART Communication Foundation.

Teflon is a registered trademark of the DuPont Company.

Third Edition
October, 2000

© Copyright 1999, 2000 by Toshiba Corporation. All rights reserved.



SAFETY PRECAUTIONS

Safety signs and labels affixed to the product and/or described in this manual give important information for using the product safely. They help prevent damage to property and obviate hazards for persons using the product.

Make yourself familiar with signal words and symbols used for safety signs and labels. Then read the safety precautions that follow to prevent an accident involving personal injury, death or damage to property.



Explanation of signal words

The signal word or words are used to designate a degree or level of hazard seriousness. The signal words used for the product described in this manual are **WARNING** and **CAUTION**.

 WARNING	Indicates a potentially hazardous situation which, if not avoided, could result in death or serious injury.
 CAUTION	Indicates a potentially hazardous situation which, if not avoided, may result in minor to moderate injuries or in property damage.







Safety symbols





The following symbols are used in safety signs and labels affixed to a product and/or in the manual for giving safety instructions.

	Indicates an action that is prohibited. Simply DON'T do this action. The prohibited action is indicated by a picture or text inside or next to the circle
	Indicates an action that is mandatory. DO this action. The mandatory action is indicated by a picture or text inside or next to the circle.
	Indicates a potential hazard. The potentially hazardous situation is indicated by a picture or text inside or next to the triangle.

SAFETY PRECAUTIONS













Safety Precautions for Installation and Wiring

 WARNING	
<p>■ Do not disconnect while circuit is live unless location is known to be nonhazardous.</p> <p> DON'T</p>	<p>Live part of electric circuit or a high temperature department can cause explosion.</p>
<p>■ Do not modify or disassemble the enclosure.</p> <p> DON'T</p>	<p>Strength degradation and defects of enclosure can cause explosion.</p>
<p>■ Do not use parts of other products.</p> <p> DON'T</p>	<p>Protective performance degradation for hazardous location can cause explosion.</p>
<p>■ Do not live circuits While assembly of all components is not over.</p> <p> DON'T</p>	<p>Protective performance degradation for hazardous location can cause explosion.</p>
<p>■ Install per the National Electrical Code for the US (NEC, ANSI/NFPA 70) and the Canadian Electrical code for Canada (CEC, CAN/CSA-C22.1).</p> <p> DO</p>	<p>Unsuitable conduit connections for hazardous location can cause explosion.</p>

 CAUTION	
<p>■ Turn off mains power before working on pipes.</p> <p> DO</p>	<p>Working on pipes while power is applied can cause electric shock.</p>
<p>■ Install a switch and fuse to isolate the LF434/LF404 from mains power.</p> <p> DO</p>	<p>Power supply from mains power can cause electric shock or circuit breakdown.</p>
<p>■ Use an appropriate device to carry and install the LF434/LF404.</p> <p> DO</p>	<p>If this product falls to the ground, injury, or malfunction of or damage to the product, can be caused.</p>
<p>■ Do not modify or disassemble the LF434/LF404 unnecessarily.</p> <p> DON'T</p>	<p>Modifying or disassembling this product can cause electric shock, malfunction of or damage to this product.</p>

SAFETY PRECAUTIONS (continued)

Safety Precautions for Maintenance and Inspection

 CAUTION	
<p>■ Turn off mains power before conducting wiring work.</p> <p> Wiring while power is applied can cause electric shock.</p> <p>DO</p>	<p>■ Ground the LF434/LF404 independently from power equipment.</p> <p> Operating this product without grounding can cause electric shock or malfunction.</p> <p>DO</p>
<p>■ Do not conduct wiring work with bare hands.</p> <p> Remaining electric charge even if power is turned off can still cause electric shock.</p> <p>DON'T</p>	<p>■ Use compression terminal lugs with insulation sleeve for the terminal block and GND terminal.</p> <p> Loose connections can cause electric shock, fire from excessive current or system malfunction.</p> <p>DO</p>
<p>■ Do not work on piping and wiring with wet hands.</p> <p> Wet hands may result in electric shock.</p> <p>DON'T</p>	<p> The label shown left is placed near the terminal board for power input. (A black border and symbol on yellow triangle) Be alert to electric shock.</p>
<p>■ Do not touch the flowmeter main body when high temperature fluid is being measured.</p> <p> The fluid raises the main body temperature and can cause burns when touched.</p> <p>DON'T</p>	<p>■ Do not conduct wiring work when power is applied.</p> <p> Wiring while power is applied can cause electric shock.</p> <p>DON'T</p>
<p>■ Do not conduct wiring work with wet hands.</p> <p> Wet hands may result in electric shock.</p> <p>DON'T</p>	<p> The label shown left is placed near the terminal board for power input. (A black border and symbol on yellow triangle) Be alert to electric shock.</p>
<p>■ Do not use a fuse other than the one specified.</p> <p> Using a fuse other than the one specified can cause system failure, damage or malfunction.</p> <p>DON'T</p>	<p>Use a rated fuse as follows:</p> <p>Fuse rating:</p> <ul style="list-style-type: none"> • 1A/250V for 100 to 240Vac or 110Vdc • 2A/250V for 24 V dc <p>Dimensions:</p> <p>Diameter 5.2 mm × 20 mm</p> <p>Melting time characteristic:</p> <p>Normal blow</p>

Disclaimer

Toshiba does not accept liability for any damage or loss, material or personal, caused as a direct or indirect result of the operation of this product in connection with, or due to, the occurrence of any event of force majeure (including fire or earthquake) or the misuse of this product, whether intentional or accidental.

Handling Precautions

- To obtain the optimum performance from the LF434/LF404 flowmeter for years of continuous operation, observe the following precautions.

(1) Do not store or install the flowmeter in:

- places where there is direct sunlight. If this is unavoidable, use an appropriate sunshade.
- places where excessive vibration or mechanical shock occurs.
- places where high temperature or high humidity conditions obtain.
- places where corrosive atmospheres obtain.
- places submerged under water.

To put the flowmeter temporarily on the floor, place it carefully with something to support it so that the flowmeter will not topple over.

(2) Execute wiring securely and correctly.

Ground the flowmeter with 100 ohm or less ground resistance. Avoid a common ground used with other equipment where earth current may flow. An independent ground is preferable

(3) Seal the cable thoroughly at the cable gland so that the cable is kept airtight. The apparatus should not be provided with the cable gland. Please prepare yourself for the cable glands which could be used in Division 2 hazardous locations.

(4) Make sure the fluid to be measured will not freeze in the detector pipe. This can cause damage to the detector pipe.

(5) Select appropriate wetted materials suited for the process fluid to be measured. Otherwise, fluid leakage due to corrosion can be caused.

(6) The converter housing covers are tightened securely at the time of shipment. Do not remove these covers or glands unless it is necessary to wire new cables or replace old ones. Otherwise, gradual deterioration of circuit isolation or damage to this product can be caused. Tighten the covers securely again if they have been removed.

Handling Precautions (continued)

- (7) Observe the following precautions when you open the converter housing cover:
- Do not open the cover in the open air unprotected against rain or wind. This can cause electric shock or cause damage to the flowmeter electronics.
 - Do not open the cover under high ambient temperature or high humidity conditions or in corrosive atmospheres. This can cause deterioration of system accuracy or cause damage to the flowmeter electronics.
- (8) This product may cause interference to radio and television sets if they are used near the installation site. Use metal conduits etc. for cables to prevent this interference.
- (9) Radio transmitters such as transceivers or cellular phones may cause interference to the flowmeter if they are used near the installation site. Observe the following precautions when using them:
- Do not use a radio transmitter while the cover of flowmeter converter is open.
 - Do not use a transceiver whose output power is more than 5 W.
 - Move the antenna of a radio transmitter at least 50 cm away from the flowmeter and signal cables when using it.
 - Do not use a radio transmitter near the flowmeter while it is operating online. The transmitter's output impulse noise may interfere with the flowmeter.
 - Do not install a radio transmitter antenna near the flowmeter converter and signal cables.
- (10) For reasons of flowmeter failure, inappropriate parameters, unsuitable cable connections or poor installation conditions, the flowmeter may not operate properly. To prevent any of these problems causing a system failure, it is recommended that you have preventive measures designed and installed on the flowmeter signal receiving side.

Table of Contents

SAFETY PRECAUTIONS	2
Handling Precautions	5
1. Product Inspection and Storage	9
1.1 Product Inspection	9
1.2 Storage	9
2. Overview	10
3. Names of Parts	11
4. Installation	14
4.1 Location	15
4.2 Mounting Procedure	16
4.3 Piping Connections	20
5. Wiring	25
5.1 Cables	27
5.2 External Device Connections and Grounding	27
5.3 Digital I/O Connections	29
5.4 Wiring Procedure	30
6. Operation	32
6.1 Preparatory Check	32
6.2 Zero Adjustment	33
7. LCD Display and Controls	34
7.1 Outline	34
7.2 Display Format	36
7.3 Basic Operations	38
7.4 Configuration Items Selection Table	44
7.5 Password Input	45
8. Configuration Parameter Setting	46
8.1 Configuration Items	46
8.2 Checking or Changing Parameters	46
9. Calibration	103
9.1 Calibration Items	103
9.2 Calibration Using Converter Signal Source	104

10. Digital I/O Functions	108
10.1 Digital I/O Specifications	109
10.2 Totalizer and Pulse Output	110
10.3 Multi-range Functions	115
10.4 High and Low Limit Alarms	120
10.5 Empty Pipe Alarm	122
10.6 Preset Point Output	123
10.7 Remote Zero Adjustment	127
10.8 Remote Selection of Fixed Value Output	128
10.9 Converter Failure Alarms	129
11. Communications Function	130
11.1 Communications with the AF100 Terminal	130
11.2 Communications Procedure	131
11.3 Cautionary Notes on Communications	132
12. Self-Diagnostics and Alarms	133
12.1 Self-Diagnostics	133
12.2 Output Status for Errors and Alarms	136
13. Maintenance and Troubleshooting	137
13.1 Maintenance	138
13.2 Troubleshooting	140
14. Principle of Operation	143
15. Specifications	144
15.1 Flowmeter Specifications	144
15.2 Type Specification Code	149
16. Outline Dimensions	151
Appendix 1. Electromagnetic Compatibility and Low Voltage Safety	154
Electromagnetic Compatibility	154
Low Voltage Safety	155

1. Product Inspection and Storage

Upon arrival of the product package, open the package and check the items contained inside. If you do not intend to install the product soon after opening the package, store the product and other related items in a place such as described in 1.2 below.

1.1 Product Inspection

The LF434/LF404 electromagnetic flowmeter is shipped in a cardboard container filled with shock-absorbing materials. Open the package carefully and check as follows:

- Make sure the following items are included in the package.
 - (1) **Model LF434/LF404 Electromagnetic Flowmeter..... 1**
 - (2) **Instruction Manual 1**
- Inspect the flowmeter for indications of damage that may have occurred during shipment.
- Make sure the type and specifications of the flowmeter are in accordance with the ordered specifications.

If you cannot find the items listed above or any problem exists, contact your nearest Toshiba representative.

1.2 Storage

To store the LF434/LF404 flowmeter after opening the package, select a storing place as follows and keep it under the conditions described below:

- (1) Avoid places where there is direct sunlight, rain or wind.
- (2) Store the product in a well-ventilated place. Avoid places of extremely high humidity or extremely high or low temperature. The following environment is recommended:
 - **Humidity range: 10 to 90% RH (no condensation)**
 - **Storage temperature: -15 to +65° C**
- (3) Avoid places where vibrations or mechanical shock occur.
- (4) Do not leave the converter housing cover open. Open the cover only when you actually start wiring cables. Leaving the cover open can cause gradual deterioration of circuit isolation.
- (5) To put the flowmeter temporarily on the floor, place it carefully with something to support it so that the flowmeter will not topple over

2. Overview

The LF434/LF404 electromagnetic flowmeter can be used in the following hazardous (classified) locations.

(1) **FM Approval**

Class I, Division 2, Groups A, B, C and D,
Class II, Division 2, Groups F and G
Class III

(2) **CSA Certification**

Class I, Division 2, Groups A, B, C and D,
Class II, Division 2, Groups E, F and G
Class III

The device measures the volumetric flow rates of electrically conductive materials on the basis of Faraday's Law of electromagnetic induction.

The device consists of two units: the detector, through which the fluid to be measured flows, and the converter, which receives the electromotive force signals from the detector, then converts the signals into the 4–20 mA dc signal.

Features

Model LF434/LF404 flowmeter has the following features:

- (1) Fluid flow is not obstructed and pressure loss is negligible.
- (2) Toshiba's original noise-suppression circuit with signal processing capabilities ensures a stable output.
- (3) Has no moving parts and flow indication is quick with high accuracy even under low flowrate measurement conditions.
- (4) No obstacles in the flow stream and nowhere remains the fluid along the detector pipe. Thus deterioration or corrosion of fluid does not occur.
- (5) High accuracy, $\pm 0.5\%$ of rate is possible for 0.3–10 m/s velocity range. 0.1 to 0.3 m/s range is available optionally.
- (6) The flowmeter has various flow measurement output and control functions as standard specifications and the optional LCD display for convenient parameter settings.
 - These functions can be selected with control keys on the panel.
- (8) Intelligent functions
 - The widely used HART protocol communications system is used as a standard feature. HART (Highway Addressable Remote Transducer) is a communications protocol for industrial sensors recommended by HCF (HART Communication Foundation).
- (9) An easy-to-read LCD display (2-line \times 16-character display) (optional)
 - The backlit LCD display can be read even under poor lighting conditions.

3. Names of Parts

The outline drawing of the LF434/LF404 flowmeter is shown in Figure 3.1 and the internal views of the LF404 converter are shown in Figures 3.2 and 3.3.

IMPORTANT

The apparatus should not be provided with the cable glands.
Please prepare yourself for the cable glands which could be used in Division2 hazardous locations.

■ **Outline Drawing**

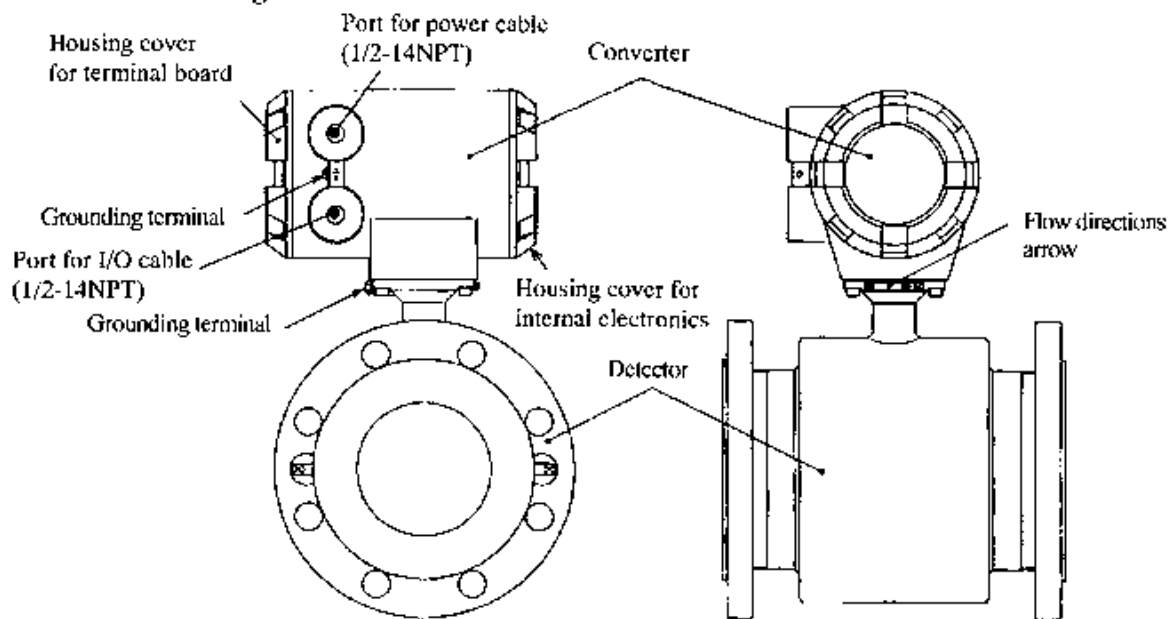

LF434/LF404 without LCD display (standard)

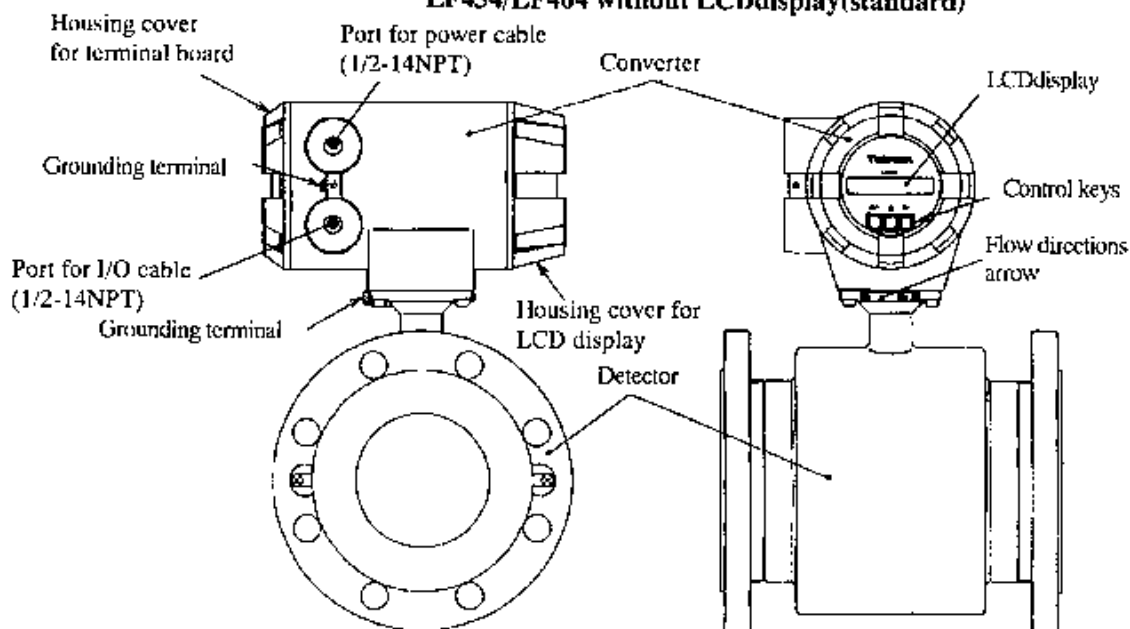

LF434/LF404 with LCD display (optional)

Figure 3.1 Outline drawing of LF434/LF404 Flowmeter

■ Terminal Board of LF404 Converter

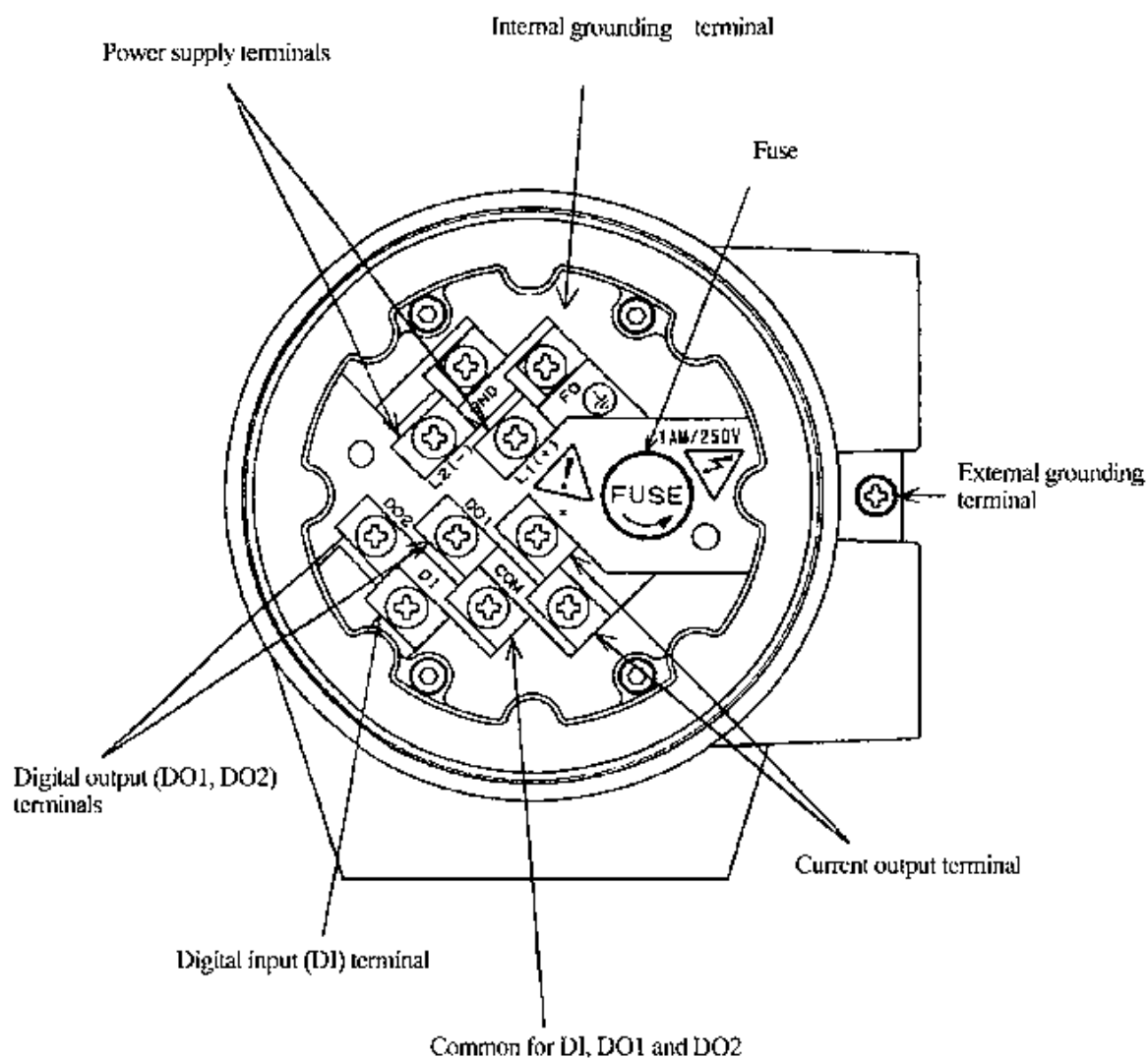

Figure 3.2 Terminal Board of LF404 Converter

■ Control switch or keys of LF404 Converter

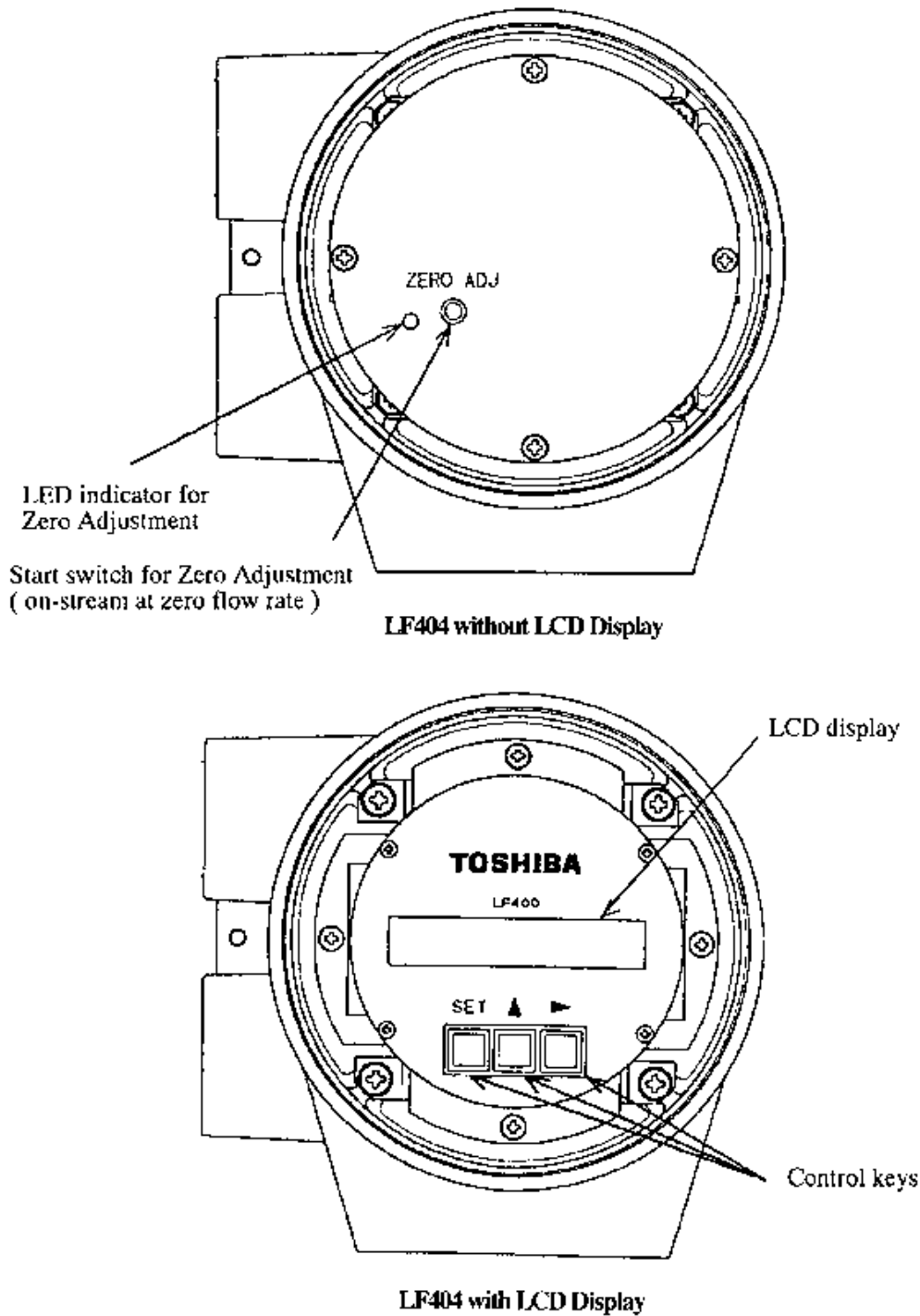













Figure 3.3 Control switch or keys of LF404 Converter

4. Installation

Safety Precautions for Installation

 WARNING	
 DON'T	<p>■ Do not live circuits under environment of explosive atmospheres.</p> <p>Live part of electric circuit or a high temperature department can cause explosion.</p>
 DON'T	<p>■ Do not use parts of other products.</p> <p>Protective performance degradation for hazardous location can cause explosion.</p>
 DON'T	<p>■ Do not live circuits While assembly of all components is not over.</p> <p>Protective performance degradation for hazardous location can cause explosion.</p>
 DO	<p>■ Install per the National Electrical Code for the US (NEC, ANSI/NFPA 70) and the Canadian Electrical code for Canada (CEC, CAN/CSA-C22.1).</p> <p>Unsuitable conduit connections for hazardous location can cause explosion.</p>



 CAUTION	
 DO	<p>■ Install a switch and fuse to isolate the LF434/LF404 from main power.</p> <p>Power supply from main power can cause electric shock or circuit breakdown.</p>
 DO	<p>■ Use an appropriate device to carry and install the LF434/LF404.</p> <p>If his product falls to the ground, injury, or malfunction of or damage to the product, can be caused.</p>
 DON'T	<p>■ Do not modify or disassemble the LF434/LF404 unnecessarily.</p> <p>Modifying or disassembling this product can cause electric shock, malfunction or damage to this product.</p>
 DO	<p>■ Ground the LF434/LF404 independently from power equipment.</p> <p>Operating this product without grounding can cause electric shock or malfunction.</p>
 DON'T	<p>■ Do not work on piping and wiring with wet hands.</p> <p>Wet hands may result in electric shock</p>
	
<p>The label shown left is placed near the terminal board for power input. (A black border and symbol on yellow triangle) Be alert to electric shock.</p>	

4.1 Location

To select the installation site, follow the precautions described below:

- Avoid places where fluid runs in a pulsating form.
- Avoid places within the immediate proximity of equipment producing electrical interference (such as motors, transformers, radio transmitters, electrolytic cells, or other equipment causing electromagnetic or electrostatic interference).
- Avoid places where excessive pipe vibration occurs.
- Avoid places where there is direct sunlight. If this is unavoidable, use an appropriate shade
- Avoid places where corrosive atmospheres or high humidity conditions obtain.
- Avoid places of too great an elevation or constricted areas where clearance for installation or maintenance work is not provided.
- Design piping so that the detector pipe is always filled with fluid, whether the fluid is flowing or not.
- The LF434 detector has no adjustable piping mechanism. Install an adjustable short pipe where needed.
- Chemical injections should be conducted on the downstream side of the flowmeter.

4.2 Mounting Procedure

 CAUTION	
<p>■ Use an appropriate device to carry and install the LF434/LF404.</p> <p> DO</p> <p>If his product falls to the ground, injury, of malfunction of or damage to the product, can be caused.</p>	<p>■ Turn off mains power before working on pipes.</p> <p> DON'T</p> <p>Working on pipes while power is applied can cause electric shock.</p>

4.2.1 Pipe checks

Before installing pipes, check for any leaning or misplacement (or eccentricity) as illustrated in Figure 4.1. An attempt to unreasonably connecting pipes that are inclined may lead to a detector breakdown or fluid leakage. Connecting pipes in an eccentric state may also cause local wears and tears of linings and grounding rings, as well as measurement errors.

Before installing pipes, make sure to flash the interior of the pipes to remove deposited matters.

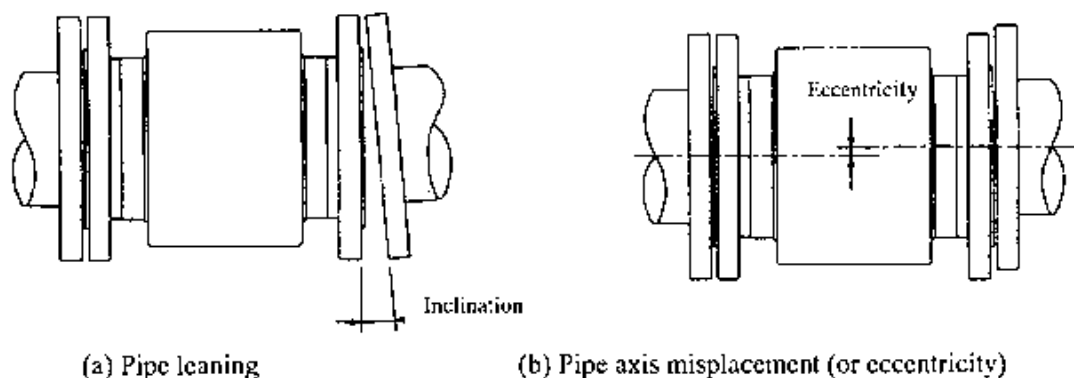

Figure 4.1 Pipe leaning and axis misplacement

4.2.2 Installation Procedure

To mount the LF434/LF404, place it between the upstream and downstream pipe flanges and tighten it with flange bolts and nuts. See Figure 4.2, Table 4.1 and follow the procedure below:

1. Place one of the flange packing next to the upstream (or downstream) pipe flange. Align the holes of the packing with those of the flange so that the holes are not obstructed.
2. Insert the LF434 detector in pipeline in accordance with the flow direction arrow on the detector.
3. Insert the bolts, one at a time, through the hole in the upstream (or downstream) pipe flange and packing, and then through the hole of the detector flange. Then thread nuts, one at a time, on each end of the bolts, finger-tighten. This will help support the detector on one side.
4. Insert the downstream (or upstream) packing between the detector flange and the downstream (or upstream) pipe flange. Align the holes of the packing with those of the flanges so that the holes are not obstructed.
5. Insert the bolts, one at a time, through the hole in the downstream (or upstream) pipe flange and packing, and then through the hole of the detector flange. Then thread nuts, one at a time, on each end of the bolts, finger-tighten. This will help support the detector.
6. While centering the detector with the longitudinal axis of the pipeline, tighten the bolts with a wrench diagonally across in even increments

IMPORTANT

When high-temperature fluid is being measured, radiant heat from the detector pipe surface and adjoining pipes may cause the ambient temperature of the converter to go above 60 °C. If the ambient temperature goes above 60 °C, try to lower the temperature by measures such as wrapping heat-insulating materials over the detector pipe and adjoining pipes.

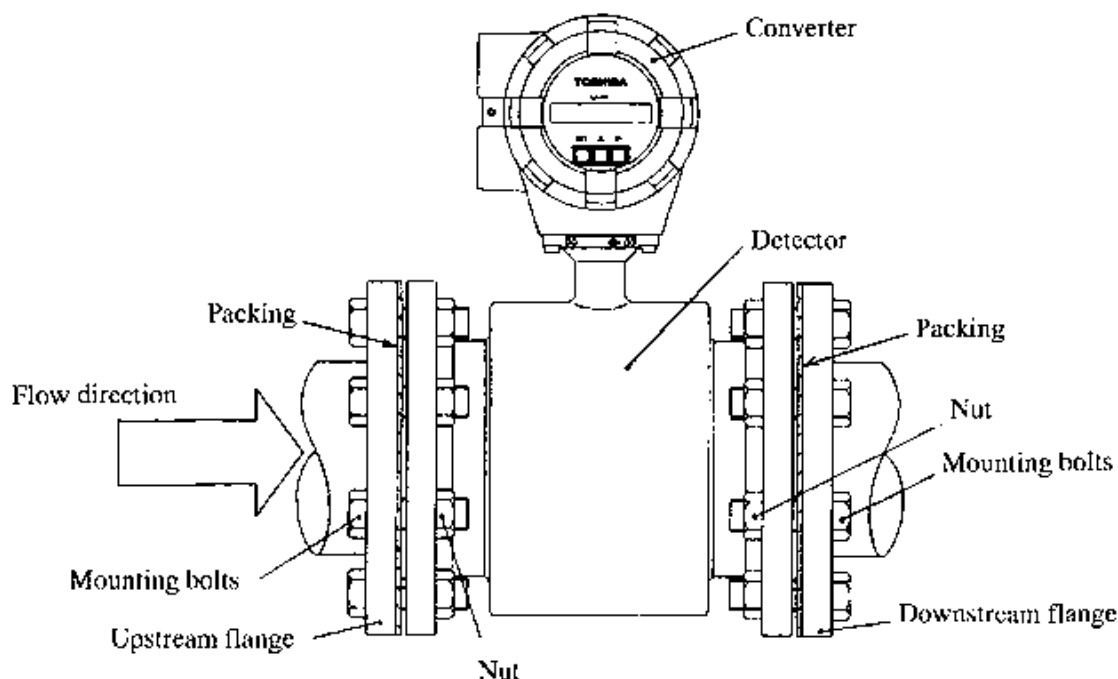

Figure 4.2 LF434/LF404 flowmeter piping connections

Table 4.1 Bolt length and Nut tightening torque

Meter size		ANSI class 150				ANSI class 300			
		Machine Bolts			Clamping torque [N·m]	Machine Bolts			Clamping torque [N·m]
		P.C.S	Diameter	Length [inch]		P.C.S	Diameter	Length [inch]	
15mm	1/2"	4	1/2"	2"	5 to 7	4	1/2"	2"	5 to 7
25mm	1"	4	1/2"	2.25"	10 to 13	4	5/8"	2.5"	13 to 16
40mm	1 1/2"	4	1/2"	2.5"	15 to 18	4	3/4"	2.8"	22 to 28
50mm	2"	4	5/8"	2.75"	26 to 32	8	5/8"	2.8"	13 to 16
80mm	3"	4	5/8"	3"	33 to 41	8	3/4"	3.4"	20 to 25
100mm	4"	8	5/8"	3"	20 To 25	8	3/4"	3.7"	24 to 30
150mm	6"	8	3/4"	3.25"	46 to 57	12	3/4"	4.1"	30 to 38
200mm	8"	8	3/4"	3.5"	60 to 75	12	7/8"	4.7"	47 to 58
250mm	10"	12	7/8"	3.9"	67 to 83	16	1"	5.4"	57 to 71
300mm	12"	12	7/8"	4"	73 to 91	16	1 1/8"	5.7"	70 to 88
350mm	14"	12	1"	4.5"	105 to 131	20	1 1/8"	5.9"	71 to 89
400mm	16"	16	1"	4.5"	98 to 123	20	1 1/4"	6.3"	98 to 123

Meter size	DIN/BS 10				DIN/BS 16			
	Hexagon head bolts			Clamping torque [N·m]	Hexagon head bolts			Clamping torque [N·m]
	P.C.S	Diameter	Length [mm]		P.C.S	Diameter	Length [mm]	
15mm	4	M12	55	5 to 7	4	M12	55	5 to 7
25mm	4	M12	60	12 to 18	4	M12	60	12 to 18
40mm	4	M16	65	19 to 23	4	M16	65	19 to 23
50mm	4	M16	65	26 to 33	4	M16	65	26 to 33
80mm	8	M16	70	17 to 21	8	M16	70	17 to 21
100mm	8	M16	75	20 to 25	8	M16	75	20 to 25
150mm	8	M20	80	48 to 60	8	M20	80	48 to 60
200mm	8	M20	85	63 to 79	12	M20	90	42 to 53
250mm	12	M20	90	60 to 75	12	M24	95	72 to 90
300mm	12	M20	90	65 to 82	12	M24	100	78 to 98
350mm	16	M20	95	62 to 78	16	M24	110	74 to 93
400mm	16	M24	105	93 to 116	16	M27	115	105 to 131

Table 4.1 Bolt length and Nut tightening torque(continued)

Meter size	JIS 10K				JIS 20K			
	Hexagon head bolts			Clamping torque [N·m]	Hexagon head bolts			Clamping torque [N·m]
	P.C.S	Diameter	Length [mm]		P.C.S	Diameter	Length [mm]	
15mm	4	M12	50	5 to 7	4	M12	55	5 to 7
25mm	4	M16	55	13 to 16	4	M16	60	13 to 16
40mm	4	M16	60	19 to 23	4	M16	65	19 to 23
50mm	4	M16	60	26 to 33	8	M16	65	13 to 16
80mm	8	M16	65	17 to 21	8	M20	75	21 to 26
100mm	8	M16	70	20 to 25	8	M20	80	25 to 32
150mm	8	M20	80	48 to 60	12	M22	90	35 to 44
200mm	12	M20	80	42 to 53	12	M22	95	46 to 58
250mm	12	M22	85	66 to 82	12	M24	110	72 to 90
300mm	16	M22	85	54 to 67	16	M24	110	59 to 74
350mm	16	M22	90	68 to 85	16	M30	125	93 to 116
400mm	16	M24	95	93 to 116	16	M30	140	116 to 145

4.3 Piping Connections

(1) Required Pipe Length

If various joints are used upstream of the detector outlet, the straight pipe length as shown in Table 4.2 is required.

Table 4.2 Required straight pipe length on the upstream side

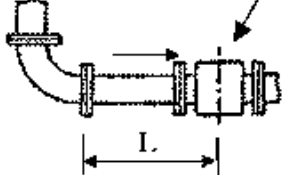
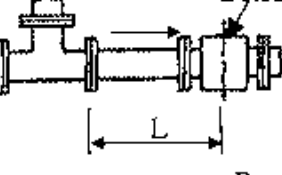
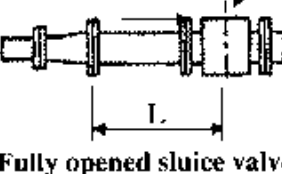
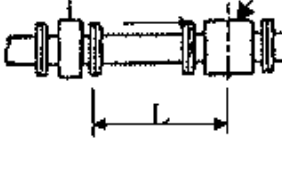
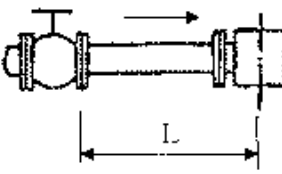
L = 5D	L = 10D
<p>(1) 90° bent</p>  <p>(2) Tee</p>  <p>(3) Diffuser</p>  <p>(4) Fully opened sluice valve</p> 	<p>(5) Other valves (not fully opened)</p> 

L: Required straight pipe length—straight pipe length plus half length of the detector.
D: Nominal bore size (diameter)

NOTES

1. The length of a reducer, if connected, can be counted as a part of the straight pipe length.
2. No straight pipe length is needed on the downstream side. If a butterfly valve is installed downstream of the detector, do not let the valve plate protrude into the pipe of the detector

(2) Pipe Orientation

The detector may be installed in horizontal, vertical or sloping pipe runs as shown in Figure 4.3. However, except for horizontal installation, fluid should flow from lower to upper directions. See Figure 4.3.

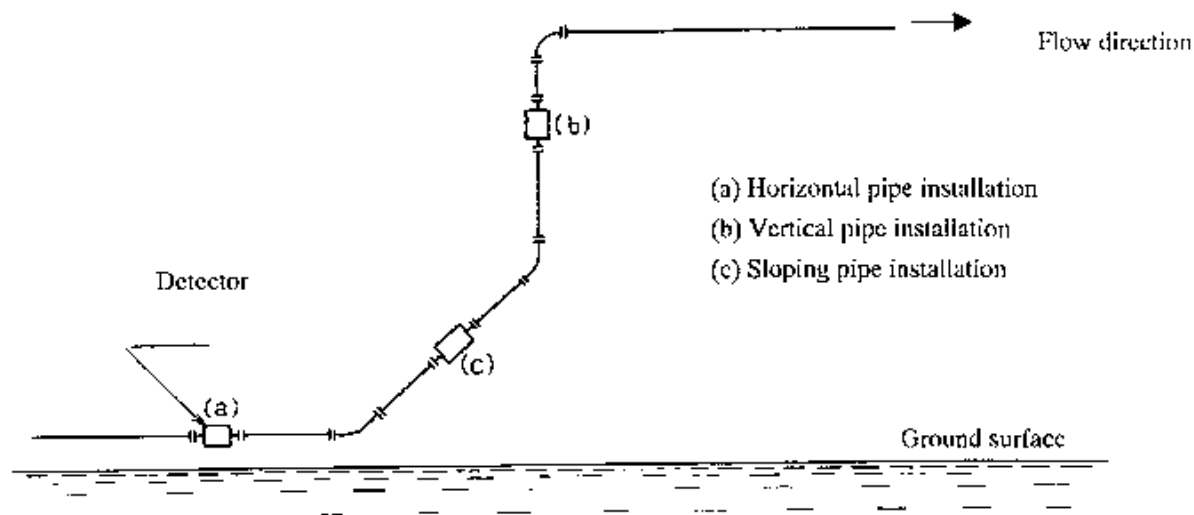

Figure 4.3 Detector Piping Orientation

The electrodes should be positioned horizontally against the ground surface in any piping installation. See Figure 4.4.

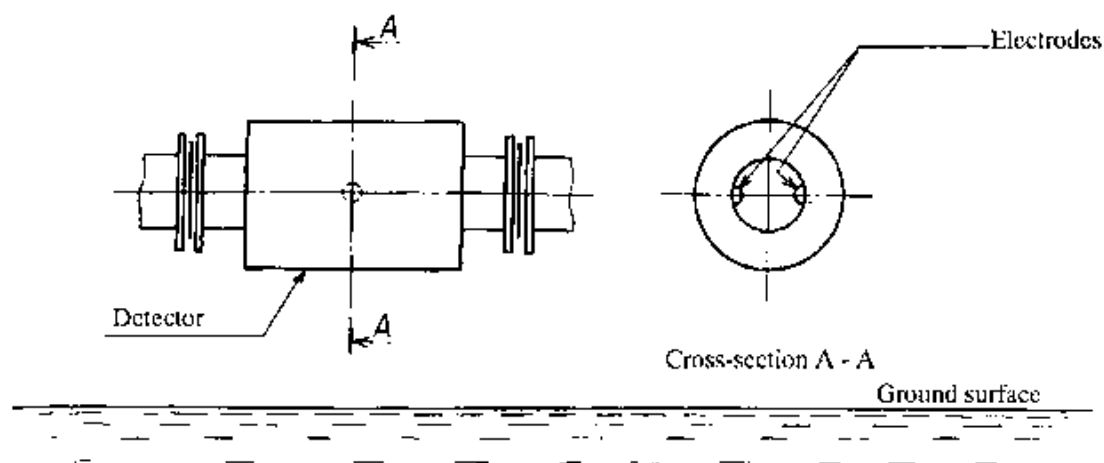

Figure 4.4 Installation position of the detector

(3) Flow Direction

Install the detector in accordance with the flow direction arrow on the detector. See Figure 4.5.

If the actual flow runs opposite to the specified flow direction, the following display and output appears. (For bidirectional multi-range measurement, see 10.3, "Multi-range Functions.").

- **LCD display (optional):** Instantaneous flow rate—indicates negative values, Totalized flow—no counts added.
- **Output:** Current output— 4.0 mA output; Pulse output—No pulses

For bidirectional range measurement, the flow in opposite direction results in a positive output value. See 10.3, "Multi-range Functions."

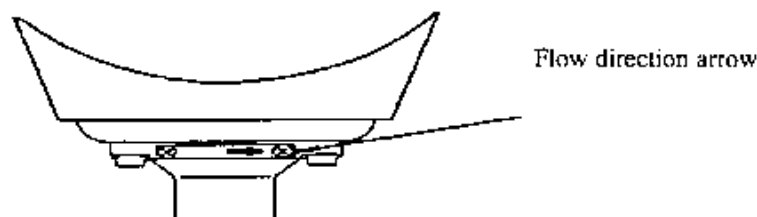

Figure 4.5 Flow direction arrow on the detector

(4) Preventing an Empty Pipe Condition

Design an upright pipe run (Figure 4.6) or sufficient head pressure (Fig. 4.7) at the downstream detector outlet if there is a possibility of the detector pipe becoming emptied.

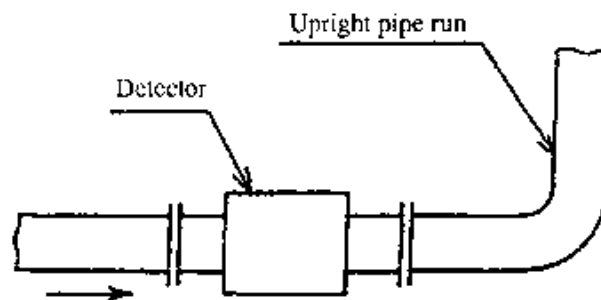

Figure 4.6 Detector with an upright pipe run at downstream outlet

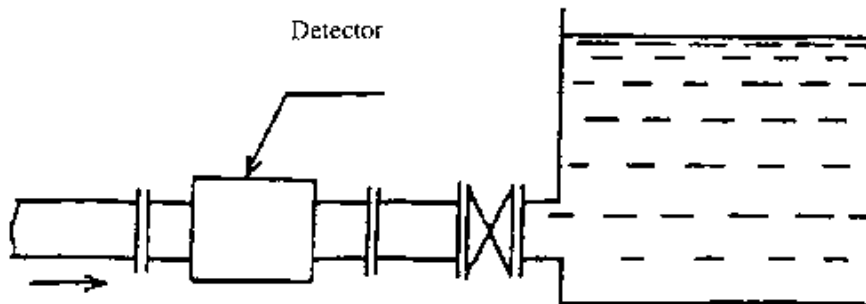

Figure 4.7 Detector with sufficient head pressure at downstream outlet

(5) Supporting Pipe

Fix the relevant pipes installed on both sides of the detector by attach fittings, etc. to support the pipe. By supporting the pipes, not only the pipe vibration is reduced but also the damage to the pipes by the electromagnetic flowmeter's weight and the fluid mass. And it protect from fluid leakage at flange face (see Figures 4.8 and 4.9).

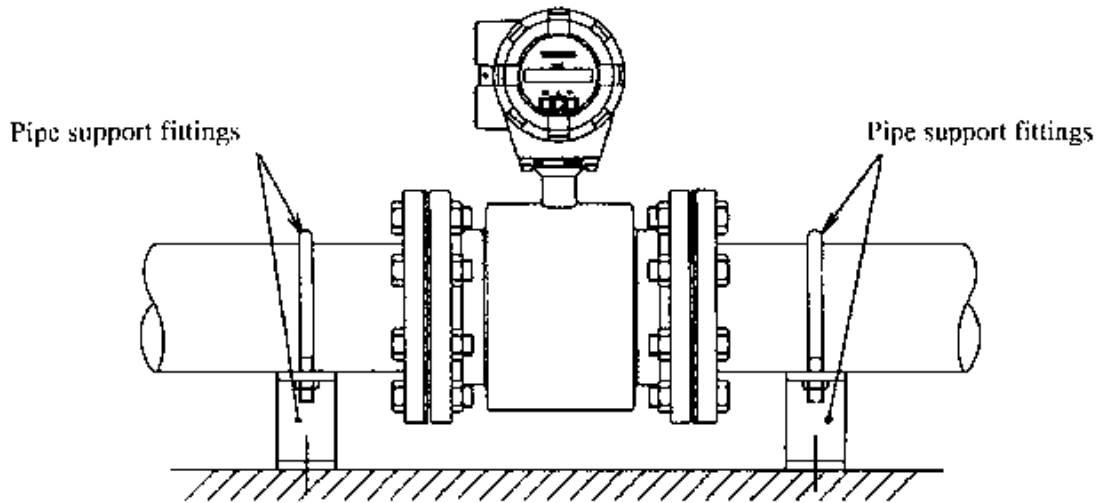

Figure 4.8 Example of Pipe Fixing Procedure

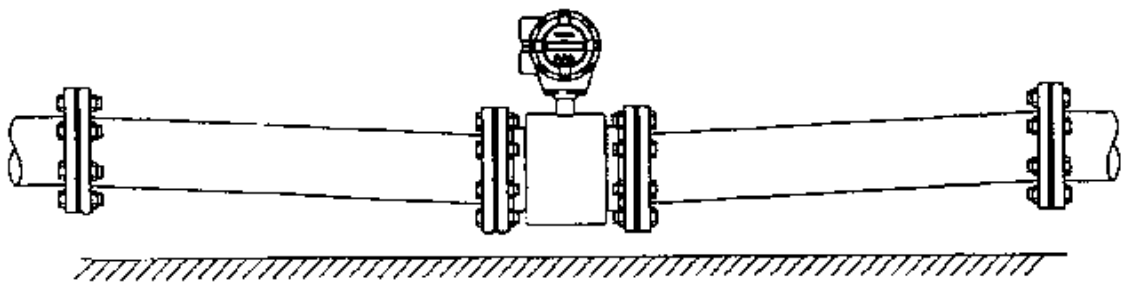

Figure 4.9 Model Diagram of Unsupported Pipes

(6) Grounding

The grounding terminal of the LF434/LF404 flowmeter should be grounded with 100 ohm or less ground resistance. Use a heavy copper braid or wire (cross-sectional area 5.5 mm² minimum) to ground the terminal and make it as short as possible. The terminal is M4 size and an M4-size crimped ring lug should be used to connect the wire to the terminal. Avoid a common ground where earth current may flow. An independent ground is preferable. See Figure 4.10. for a conductive pipeline grounding and non-conductive pipeline grounding procedures.

To prevent a two-point grounding, ground the shielded cable on the receiving instrument side.

■ If connection pipe is conductive:

Connect between the grounding terminal and both ends of the mating flanges with a heavy copper braid or wire (cross-section 5.5 mm² minimum).

■ If connection pipe is non-conductive:

Use a heavy copper braid or wire (cross-section 5.5 mm² minimum) to ground the terminal with 100 ohm or less ground resistance.

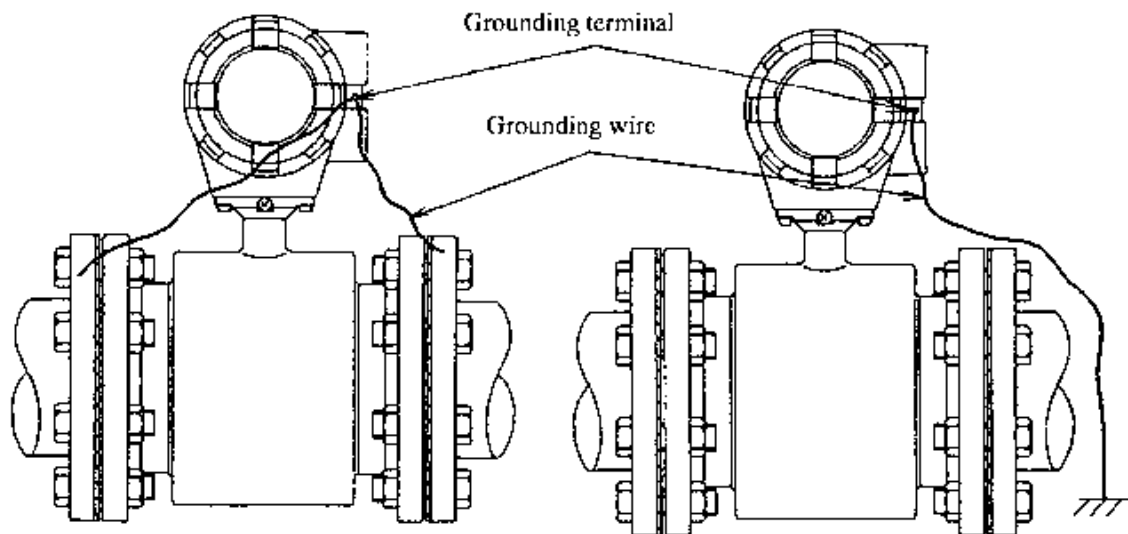













Figure 4.10 Grounding Procedure

5. Wiring

 WARNING	
<p>■ DO NOT DISCONNECT WHILE CIRCUIT IS LIVE UNLESS LOCATION IS KNOWN TO BE NONHAZARDOUS.</p>	
 DON'T	<p>Live part of electric circuit or a high temperature department can cause explosion.</p>
<p>■ Do not live circuits While assembly of all components is not over.</p>	
 DON'T	<p>Protective performance degradation for hazardous location can cause explosion.</p>
<p>■ Install per the National Electrical Code for the US (NEC, ANSI/NFPA 70) and the Canadian Electrical code for Canada (CEC, CAN/CSA-C22.1).</p>	
 DO	<p>Unsuitable conduit connections for hazardous location can cause explosion.</p>

 CAUTION	
<p>■ Do not work on piping and wiring with wet hands.</p>	<p>■ Ground the LF434/LF404 properly.</p>
 DON'T	 DO
<p>Wet hands can cause system failure.</p>	<p>Operating this product without a grounding can cause system malfunction.</p>
<p>■ Do not modify or disassemble the LF434/LF404 unnecessarily.</p>	<p>■ Prepare yourself for the cable glands which could be used in Division 2 hazardous locations.</p>
 DON'T	 DO
<p>Modifying or disassembling this product can cause electric shock, malfunction or damage to this product.</p>	<p>The apparatus should not be provided with the cable glands.</p>
<p>■ Use the proper cables for wiring of power and I/O .</p>	<p>■ The label shown left is placed near the terminal board for power input. Be alert to electric shock.</p>
	
<p>Using a cable other than the one specified may cause system failure or damage and may break waterproof.</p>	<p>The label shown left is placed near the terminal board for power input. Be alert to electric shock.</p>

Flowmeter accuracy may be affected by the way wiring is executed. Proceed with wiring taking the following precautions:

- (1) Select the cable runs away from electrical equipment (motors, transformers, or radio transmitters) which causes electromagnetic or electrostatic interference.
- (2) Deterioration of flowmeter circuit insulation occurs if the converter interior or cable ends get wet or humidified. This in turn causes malfunction of flowmeter or noise problems. Avoid a rainy day if the flowmeter is to be installed outdoors. Even indoors, prevent water from splashing over the flowmeter. Try to finish the wiring as quickly as possible
- (3) The converter has a surge-absorbing barrier installed inside. Therefore, do not conduct a withstand voltage test for the converter. To check the insulation of the converter, use a voltage of 250 V dc or less.

5.1 Cables

Use the kind of cables shown in Table 5.1 to wire the converter.

Table 5.1 Cables

Name	Cable type	Nominal cross-sectional area	Overall diameter
Power cable	Three-wire sheathed cable (Note)	2 mm ²	11 to 13 mm
I/O cable	The number of wires for the output cable depends on the system specifications. Use a shielded cable with nominal cross-sectional area of 1.25 mm ² and overall diameter of 11 to 13 mm.		

Note: Use a four-wire cable if the arresters are to be used. See Figure 5.1 below.

5.2 External Device Connections and Grounding

The terminal board connections of the LF434/LF404 flowmeter are shown in Figure 5.1.

Proceed with wiring as described in Section 5.4, "Wiring Procedure."

If power supply is specified as DC, use I.1 as positive (+) and I.2 as negative (-) terminals.

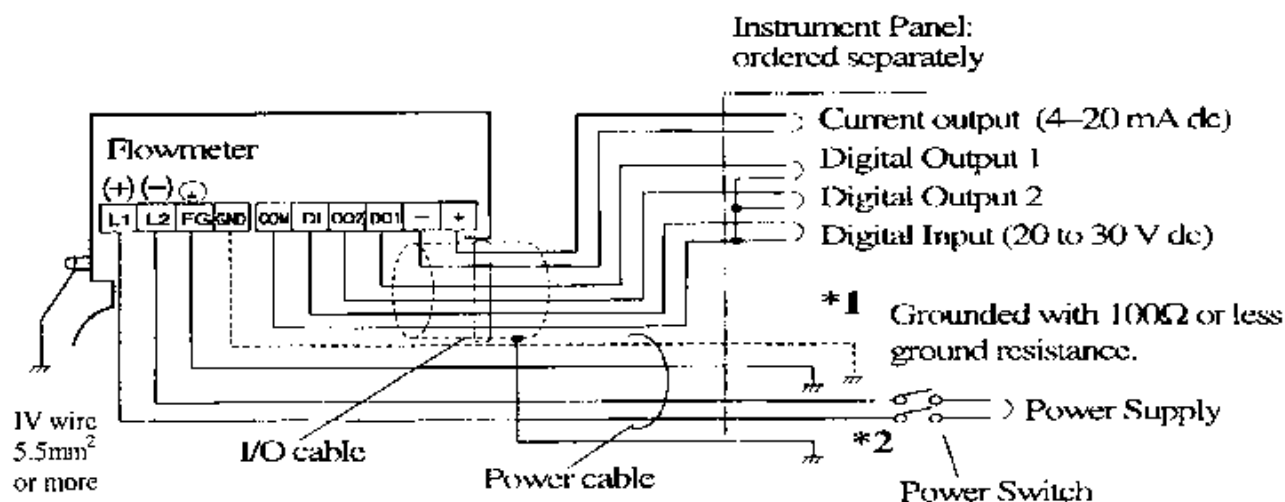

*1 To use the arresters, ground the GND terminal using the wire shown in broken line.

*2 Locate an external double-pole power switch on the power line near the flowmeter and within easy operation. Mark one the switch as the disconnecting device for the flowmeter.

Use an appropriate switch of the rating shown below:

Recommended switch rating;	Rating	250 V ac, 6A or more
	Inrush current	15 A or more

Figure 5.1 Terminal Block Connections

IMPORTANT

- (1) The grounding terminal of the LF434/LF404 flowmeter should be grounded with 100 ohm or less ground resistance. Use a heavy copper braid or wire (cross-sectional area 5.5 mm^2 minimum) to ground the terminal and make it as short as possible. The terminal is M4 size and an M4-size crimped ring lug should be used to connect the wire to the terminal. Avoid a common ground where earth current may flow. An independent ground is preferable. See Figure 5.2. for a conductive pipeline grounding and non-conductive pipeline grounding procedures.
- (2) To prevent a two-point grounding, ground the shielded cable on the receiving instrument side.

■ If connection pipe is conductive:

Connect between the grounding terminal and both ends of the mating flanges with a heavy copper braid or wire (cross-section 5.5 mm^2 minimum).

■ If connection pipe is non-conductive:

Use a heavy copper braid or wire (cross-section 5.5 mm^2 minimum) to ground the terminal with 100 ohm or less ground resistance.

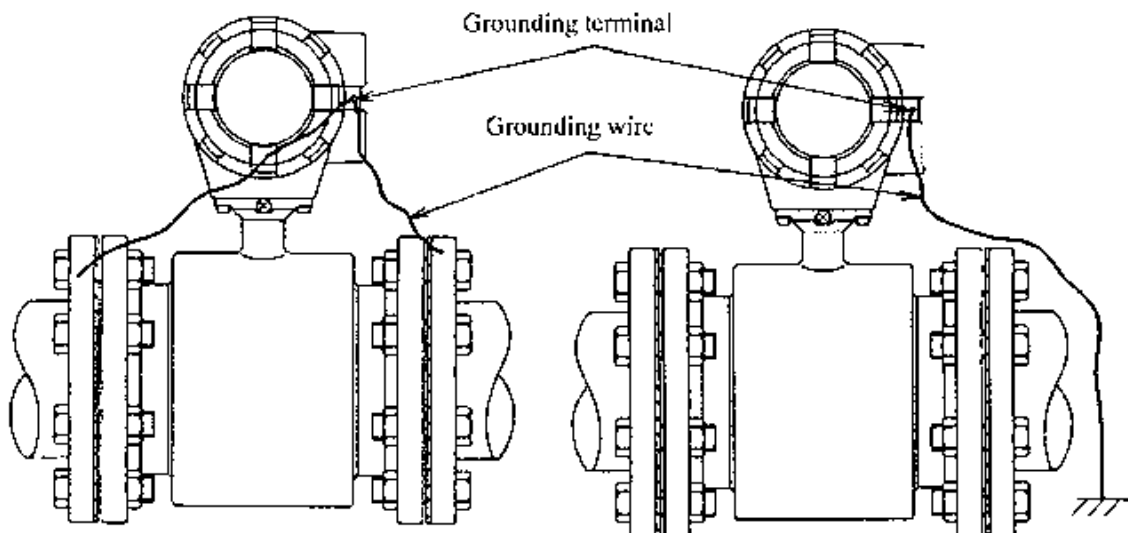

Figure 5.2 Grounding Procedure

5.3 Digital I/O Connections

Digital I/O terminals consist of contact output terminals (standard DO1 and optional DO2), voltage signal input terminal (DI, optional), and signal common terminal (COM). Each terminal (DO1, DO2 and DI) is isolated from internal circuits. Terminal (COM) is the signal common for the other three terminals (DO1, DO2 and DI).

Functions can be assigned for each terminal with the LCD control keys (option). See Chapter 10, "Digital I/O Functions."

To connect an electromagnetic relay or counter to the contact output terminal (DO1 or DO2), put a surge-absorbing diode into the input circuit of the relay or counter. See Figure 5.3 for an example of electromagnetic counter connection.

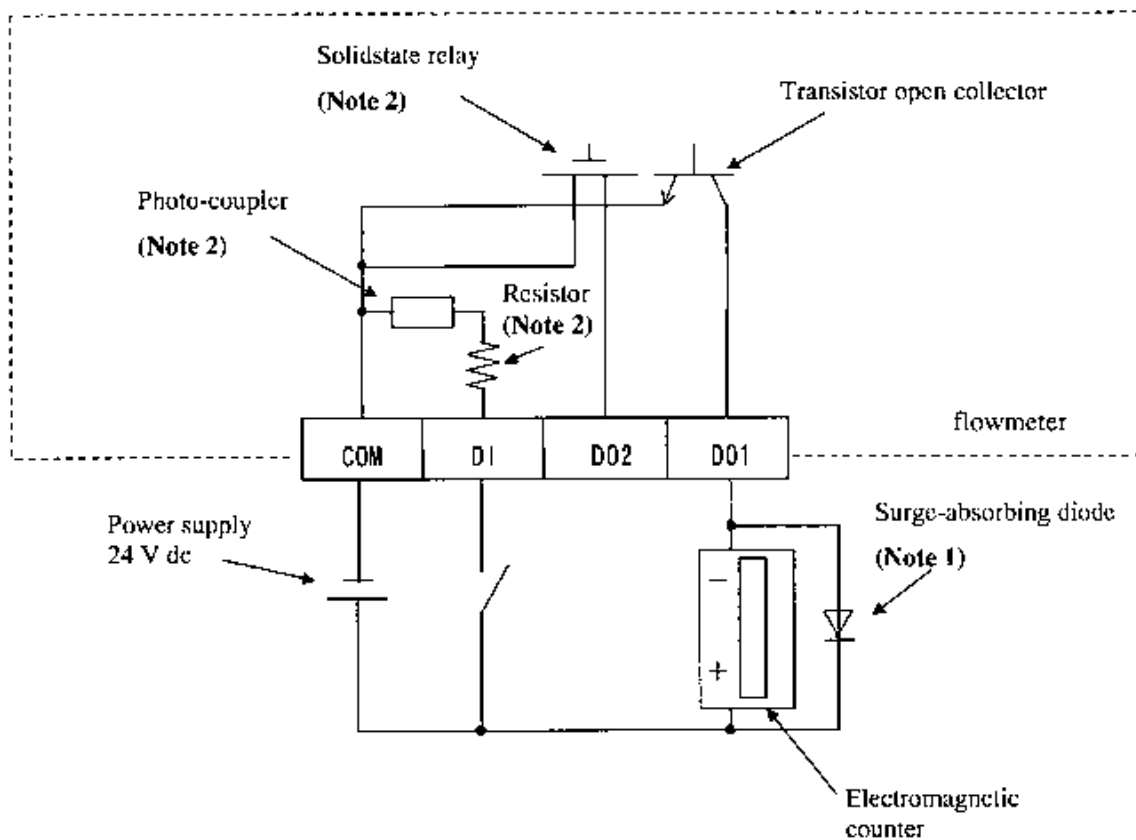

Note 1: Use a surge-absorbing diode of the rating: current rating 1A and voltage rating 200 V minimum.

Note 2: The Solidstate relay, photo-coupler and resistor are not provided for the standard model (the one with no digital I/O specifications). Leave the terminals for DO2 and DI open.

Figure 5.3 Electromagnetic Counter Connection Example

5.4 Wiring Procedure

Cable termination and cable connections are described below.

5.4.1 Cable Termination

CAUTION	
<p>■ Do not conduct wiring work when power is applied.</p> <p style="text-align: center;"> </p> <p style="text-align: center;">DON'T</p> <p style="margin-left: 20px;">Wiring while power is applied can cause electric shock.</p>	<p>■ Do not work on piping and wiring with wet hands.</p> <p style="text-align: center;"> </p> <p style="text-align: center;">DON'T</p> <p style="margin-left: 20px;">Wet hands may result in electric shock.</p>

<p>IMPORTANT</p> <p>The apparatus should not be provided with the cable glands.</p> <p>Please prepare yourself for the cable glands which could be used in Division2 hazardous locations.</p>
--

Use cables as specified in Table 5.1. First, Remove the cable sheath about 70 mm from the end to expose the coated wires and then strip the wires about 10 mm. Then attach an M4-size compression terminal lug to the end of each wire using a compression tool. The compression terminal should be of the kind with insulated sleeve to prevent shorts between adjacent terminals. The overall length of the wire with the terminal attached should be about 60 mm. See Figure 5.4 below.

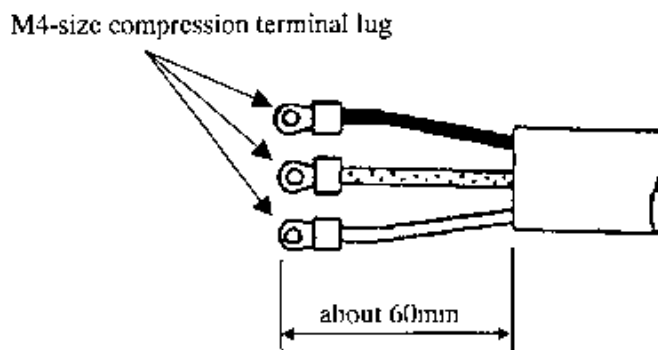

Figure 5.4 Termination of cables

5.4.2 Cable Connections

Connect the terminated cable wires to the terminal board as described below.

IMPORTANT

Connect the wires securely to the terminal board. A loose connection may result in unsatisfactory flowmeter performance. Make sure the wires are securely connected.

- (1) Remove the housing cover for the terminal board shown in Figure 3.1. The terminal board is located inside the converter as shown in Figure 3.2. Connect the crimped terminal of each wire to the specified pin of the terminal board. See Figure 5.1 for the terminal board configuration. Tighten each crimped terminal to the terminal board with a screw using a Phillips screwdriver as shown in Figure 5.6. Loose connection may result in unsatisfactory flowmeter performance. Make sure the wire is securely connected.

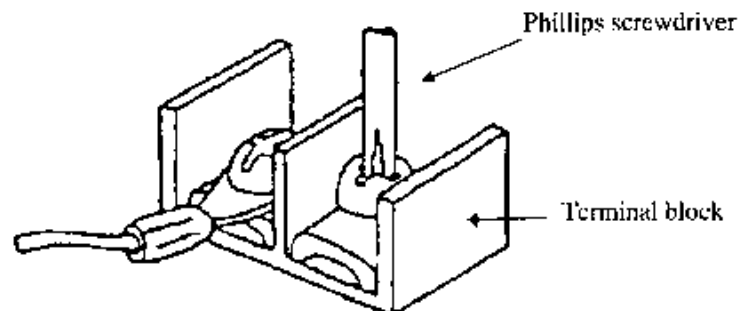



Figure 5.5 Terminal board connections

NOTE

The appropriate torque for tightening the terminal board screws is 1.2 Nm (12 kgf·cm).

- (2) After the terminal block connection, pull the cable a little so that the cable runs straight from the terminal block without unnecessary winding.
- (3) Attach the terminal cover and screw the housing cover for the terminal block. To keep the housing seal, tighten securely the cover using a tool fitting with the groove on the cover.

6. Operation

 CAUTION	
<ul style="list-style-type: none"> ■ Do not touch the LF434/LF404 main body when high temperature fluid is being measured. 	<p>The fluid raises the main body temperature and can cause burns when touched.</p>
 DON'T	

6.1 Preparatory check

Follow the procedure described below to prepare before starting the flow measurement.

System Check

- Check the wiring between the converter and related instruments.
- Make sure all the bolts of connection flanges on which the flowmeter is mounted securely tightened.
- Make sure the direction of flow arrow is in accordance with actual flow.
- Make sure the flowmeter is grounded with 100 ohm or less ground resistance.
- Make sure the converter housing covers are securely tightened.

Placing System On-Stream

- Let the fluid go through the detector pipe. When the detector is filled with the fluid, stop the fluid and keep it still in the detector pipe.

Supplying Electric Power

- Make sure the power supply is as specified.

Checking Converter Parameters

- Check the configuration parameter settings. Refer to Chapter 7, "LCD Display and Controls," Chapter 8, "Configuration Parameter Setting," and Chapter 11, "Communications Function."

Zero Adjustment

- Wait for 30 minutes to warm up the flowmeter. Then making sure the fluid holds still in the detector pipe, starts the zero adjustment. Refer to 6.2, "Zero Adjustment."

On-line measurement

After checking the items and conducting the zero adjustment as listed above, let the fluid go through the detector pipe. Output (4–20 mA dc) directly proportional to the flow rate can be obtained.

6.2 Zero Adjustment

To conduct zero adjustment of the flowmeter, the fluid in the detector pipe must be held still.

There are three different ways to start the zero adjustment:

- (1) Pressing the zero adjustment switch for the model without LCD display
- (2) Pressing a combination of control keys for the model with LCD display
(see 8.2.8, "Zero Adjustment")
- (3) Sending a command signal from a HART communications device
(such as the AF100 hand-held terminal).

The following is the procedure for starting the zero adjustment for the model without LCD display.

- Press the zero adjustment switch for more than 3 seconds.

(Note that once the zero adjustment is started, there is no way to cancel the zero adjustment sequence.)

Then the LED indicator lights and the zero adjustment sequence will start. The zero adjustment sequence lasts about 3 to 6 seconds. (Zero adjustment duration depends on the excitation current frequency. It takes about 3 seconds for 24 Hz setting and about 6 seconds for 12 Hz and 6 Hz settings.)

When the zero adjustment sequence ends, the LED indicator goes off.

To conduct the zero adjustment, it is necessary to open the converter housing cover for internal electronics and press the switch. Observe the following precautions when you open the housing cover:

- (1) Do not open the cover in the open air unprotected against rain or wind.
If you adjust the flowmeter in the rain, this can cause electric shock or damage to the flowmeter electronics. If wind blows against the internal circuitry of the converter, output may fluctuate and fail to indicate correct measuring values.
- (2) Do not conduct the zero adjustment when the ambient humidity is high. By opening the cover in high humidity conditions, the measuring accuracy may be reduced or damage caused to the flowmeter electronics.

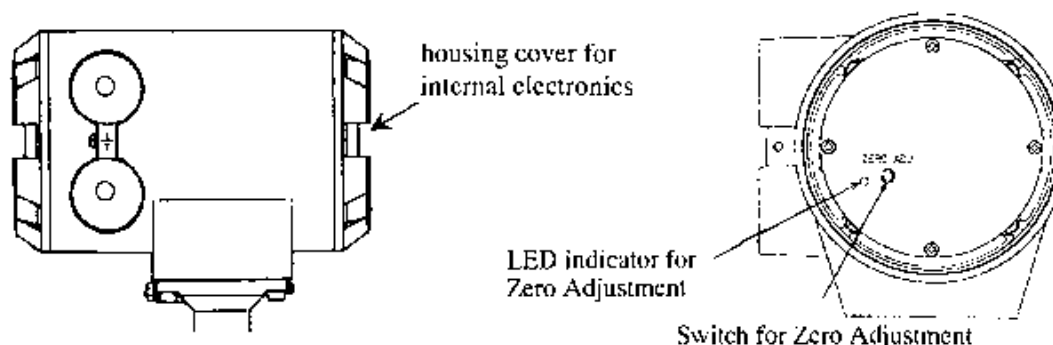

7. LCD Display and Controls (option)

You can select the operation mode, change the configuration parameters or execute operation-specific functions using the control keys on the panel. How to operate these keys is described in this chapter.

7.1 Outline

The LF404 Converter has an optional LCD display. The LCD display can be used to set and indicate various configuration parameters. Figure 7.1 shows the front view of LCD display.

- (1) Do not open the housing cover for LCD display in the open air unprotected against rain or wind. If you open the housing cover for LCD display in the rain, it can cause electric shock or damage to the flowmeter electronics. If wind blows against the internal circuitry of the converter, the output may fluctuate and fails to indicate correct measuring values.
- (2) Do not open the housing cover for LCD display when the ambient humidity is high. By opening the cover in high humidity conditions, the measuring accuracy may be reduced or damage caused to the flowmeter electronics.

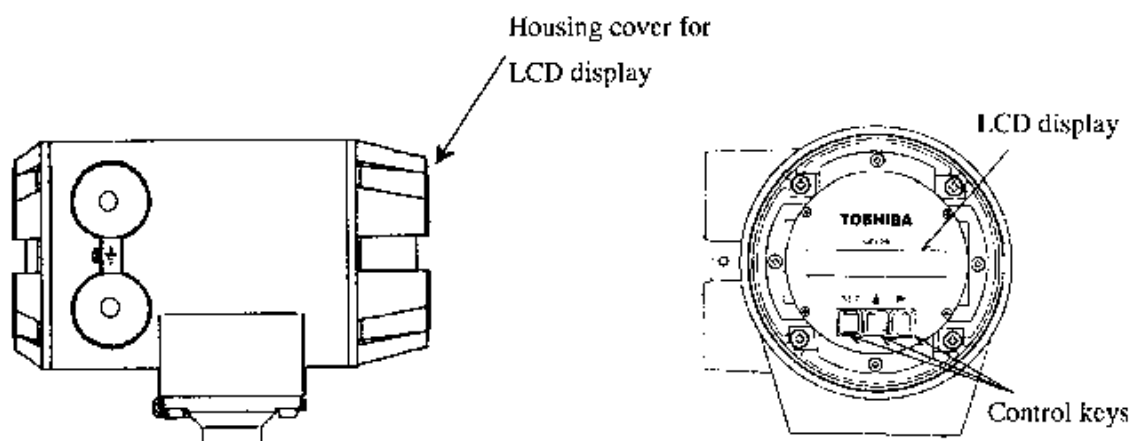

Figure 7.1 LF404 Converter with LCD display



■ LCD display

A 2-line × 16-character liquid crystal display. The backlit display enables an easy-to-read indication even under poor lighting conditions. Instantaneous flow rates or totalized flow in the measurement mode, or configuration parameters in the setting mode can be displayed.

■ **Control Keys**

Changing the operation mode, checking or changing parameters can be done with these keys. To operate these keys, you have to open the converter housing cover. Observe the following precautions when you open the housing cover:

Functions of each control key when pressed are shown in the table below.

Control keys	Basic functions of control keys
<p>SET</p> 	<p>Goes into the items selection sequence.</p> <div style="display: flex; align-items: center; justify-content: center;"> <div style="border: 1px solid black; padding: 5px; text-align: center;"> 10.00 m/s 100.0 % measurement mode </div> ➡ <div style="border: 1px solid black; padding: 5px; text-align: center;"> A1:EX. CURR selection sequence </div> </div>
	<p>Goes into the detailed-item specifying sequence for each selected item in measurement, setting or calibration modes.</p> <div style="display: flex; align-items: center; justify-content: center;"> <div style="border: 1px solid black; padding: 5px; text-align: center;"> A1:EX. CURR. selection sequence </div> ➡ <div style="border: 1px solid black; padding: 5px; text-align: center;"> A1:EX. CURR. 0.2100A measurement mode </div> </div>
	<p>Stores the selected data in the setting mode.</p> <div style="display: flex; align-items: center; justify-content: center;"> <div style="border: 1px solid black; padding: 5px; text-align: center;"> B1:UNIT 1 % status of changing the data </div> ➡ <div style="border: 1px solid black; padding: 5px; text-align: center;"> B1:UNIT 1 % status of finish changing </div> </div>
	<p>Changes items (alphabet letter and number) in the items selection sequence, and changes parameters (numbers and/or units) in the detailed-item specifying sequence in measurement, setting or calibration modes.</p> <div style="display: flex; align-items: center; justify-content: center;"> <div style="border: 1px solid black; padding: 5px; text-align: center;"> C2:RANGE 1 02.000 m/s date:0.2000m/s </div> ➡ <div style="border: 1px solid black; padding: 5px; text-align: center;"> C2:RANGE 1 03.000 m/s date:0.3000m/s </div> </div>
	<p>Starts and stops the totalizer in the measurement mode. (Note)</p> <div style="display: flex; align-items: center; justify-content: center;"> <div style="border: 1px solid black; padding: 5px; text-align: center;"> F 1000 m³ 100.0 % stop the totalizer </div> ➡ <div style="border: 1px solid black; padding: 5px; text-align: center;"> F 1001 m³ C 100.0 % start the totalizer </div> </div>
	<p>Changes digits (alphabet letter and number) in the items selection sequence, and starts the detailed-item specifying sequence by indicating the left-most digit with the cursor.</p> <div style="display: flex; align-items: center; justify-content: center;"> <div style="border: 1px solid black; padding: 5px; text-align: center;"> D1: DAMPING 00.5 S setting mode </div> ➡ <div style="border: 1px solid black; padding: 5px; text-align: center;"> D1: DAMPING 00.5 S status of finish changing </div> </div>
	<p>Moves the cursor from left to right (from the right end reverts to the left end) in the above sequence.</p> <div style="display: flex; align-items: center; justify-content: center;"> <div style="border: 1px solid black; padding: 5px; text-align: center;"> G1: COUNT RATE 1.23E-4 m³ Indicate cursor under '1' </div> ➡ <div style="border: 1px solid black; padding: 5px; text-align: center;"> G1: COUNT RATE 1.23E-4 m³ Indicate cursor under '2' </div> </div>
	<p>Resets the totalizer in the measurement mode. (Note)</p> <div style="display: flex; align-items: center; justify-content: center;"> <div style="border: 1px solid black; padding: 5px; text-align: center;"> F 1000 m³ C 100.0 % start the totalizer </div> ➡ <div style="border: 1px solid black; padding: 5px; text-align: center;"> F 0 m³ C 100.0 % reset the totalizer </div> </div>

Note: To operate the totalizer, it is preferable to set the indicating unit (UNIT 1 and/or UNIT 2) to one of the units appropriate for totalization just to make sure it is operating correctly. See 10.2, "Totalizer and Pulse Output."

7.2 Display Format

In the measurement mode, measured data are displayed in UNIT 1 (primary indicating unit) and UNIT 2 (secondary indicating unit). As to indicating units, see 8.2.4, "Indicating Unit."

■ **Display Format**

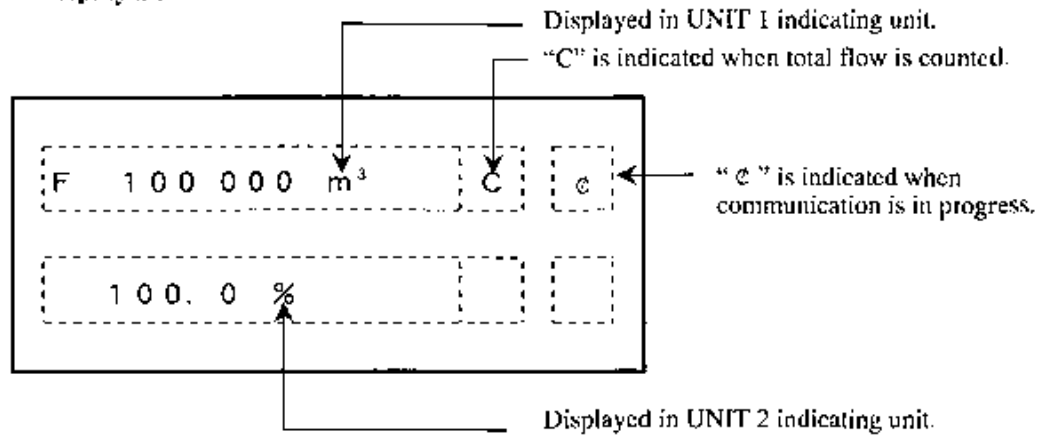

■ **Measured Value Display Format**

(1) **Flow rate**

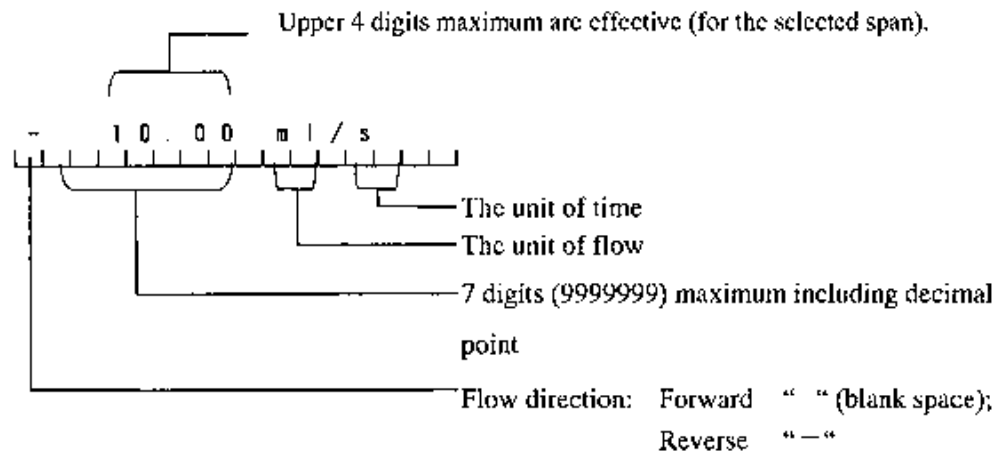

(2) Totalizer

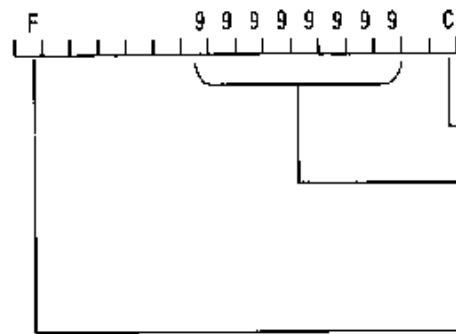

"C" is indicated when total flow is counted.

Increments per counting rate. Refer to 8.2.10, "Counting Rate."

Wraps around after 99999999.

"F" for forward and "R" for reverse direction flow will be displayed

(3) Volumetric flow

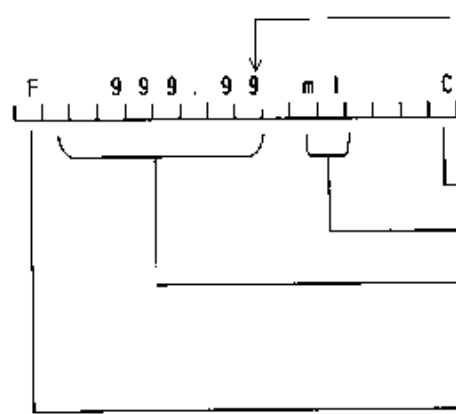

Displays down to the smallest digit of counting rate.

"C" is indicated when volumetric flow is counted.

The unit of flow

8 digits (99999999) maximum including decimal point

If the flow count exceeds 99999999, wraps around.

"F" for forward and "R" for reverse direction flow will displayed.

(4) % display

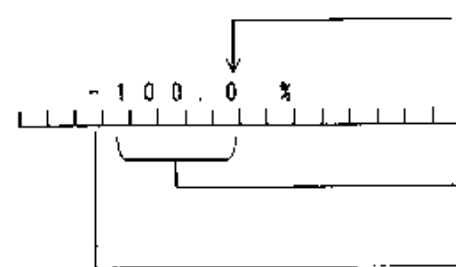

Displayed down to 0.1 %.

Displays up to 125.0 %.

Flow direction: Forward " " (blank space);
Reverse " - "

7.3 Basic operations

Flow measurement in the measurement mode, checking or changing configuration parameters in the setting mode and a converter unit check in the calibration mode are the basic operations of the LF404 converter.

7.3.1 Mode Change

The LF404 converter has three operation modes: measurement, setting and calibration. The system stays in the measurement mode after the power is turned on. To change the mode to the setting or calibration mode, press [SET] and select the desired item using [▶] and [▲] keys. To return to the measurement mode, select "0" (MEASURE MODE) for the number column of configuration items (such as A0 or B0). See 7.4, "Configuration Items Selection Table."

■ Measurement mode

: measures the process flow and displays and outputs the measured process values. The flowmeter can measure the flow velocity, flow rates, or totalized flow. The flowmeter first goes into this mode when power is turned on.

■ Setting mode

: used to check or change various configuration parameters used in the measurement mode. These parameter values are displayed while checking or changing these values but the flowmeter outputs the measured process values as in the measurement mode. See 7.4, "Configuration Items Selection Table" and 8.2, "Checking or Changing Parameters" for details. Configuration items are from A1, A2, A3 to M1.

■ Calibration mode

: used to check the converter internal circuits. The internally generated simulation signal is used to check the measuring span and excitation current value. The current output of the flowmeter changes in accordance with the simulation signal. The status of each digital output is held to the value just before the system moved into the calibration mode. See 7.4, "Configuration Items Selection Table" and Chapter 9, "Calibration" for details. Configuration items are from N1 to N4.

Change mode flow



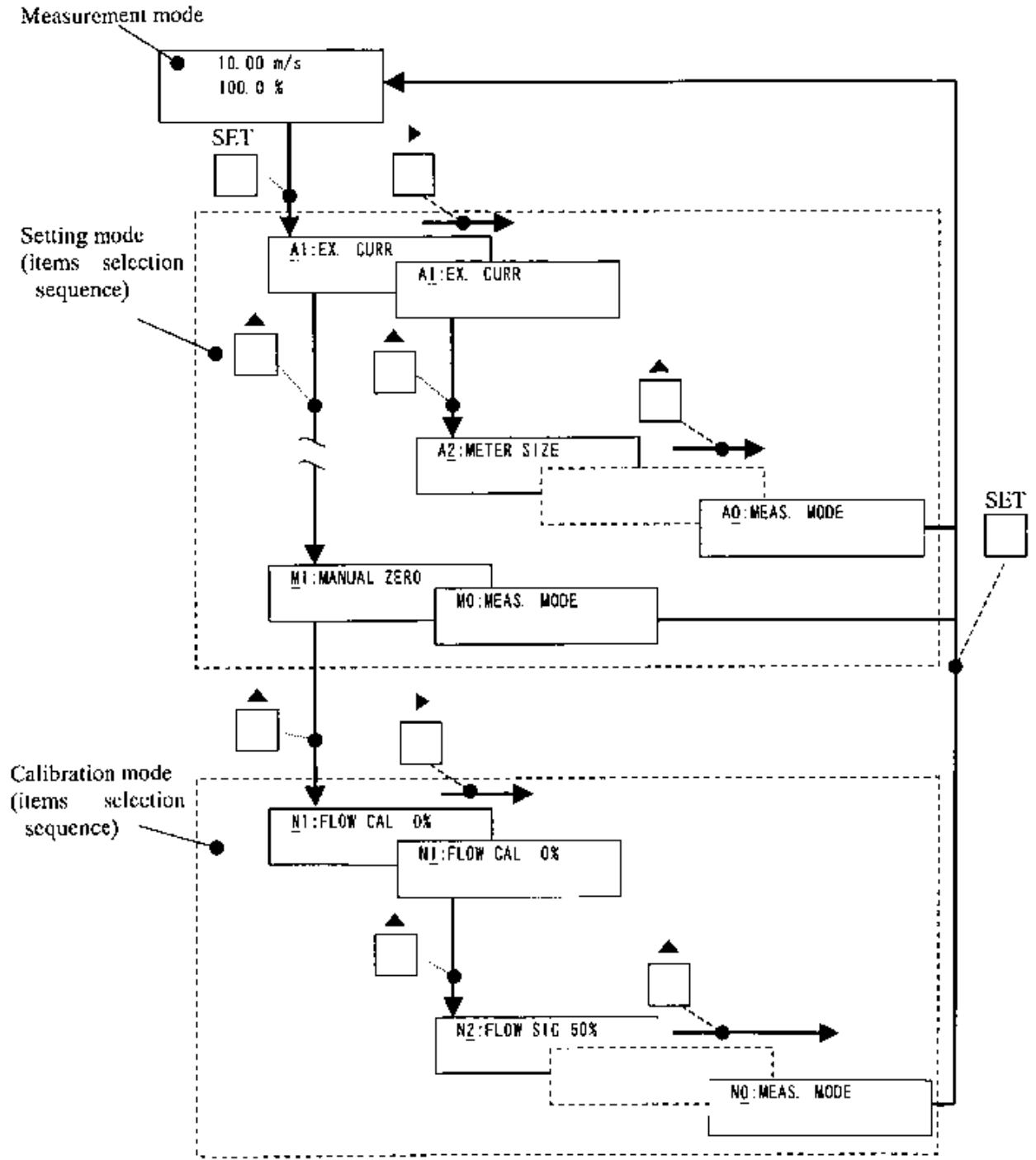



 are shown to control keys, and LF404 display is changed to indicated.



7.3.2 Configuration Parameter Selection in Setting and Calibration Modes







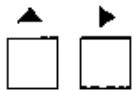

Process as follows to select the desired items, to check or change the item setting value.

- To select the desired item :



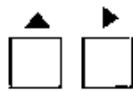



Key operation	Display example	Description
	10.00 m/s 100.0 %	Measure value displays.(Measurement mode)
SET 	A1: EX. CURR.	Pressing [SET], the system changes to the items selection sequence. (Note) And the cursor appears under alphabet (A).
	B1: UNIT1	Change the alphabet to "B" by pressing [▲]. * If cursor is the number, the number is increased by pressing [▲].
	B1: UNIT1	Then move the cursor to the number by pressing [▶] * If cursor is the number, the cursor is changed to the alphabet by pressing [▶].
 	C2: RANGE 1	Selects the desired item (indicated by an alphabet letter and a number) first by selecting the digit (alphabet or number) with [▶] and then changing the value with [▲]. The example shows "C2: RANGE 1"

Note: In case of that the converter is type for special specifications and setted password, changing measurement mode to items selection sequence, password-input mode appears.
See 7.5 "Password Input" for details about Password-input mode
See 7.3.3 "Converter for Special specifications" for to differentiate the converter for special specifications and normal.

■ To change the setting value:

Key operation	Display example	Description
	C2: RANGE 1	Items selection sequence displays. Selects the desired item (indicated by an alphabet letter and a number) first by selecting the digit (alphabet or number) with [▶] and then changing the value with [▲]. The example shows "C2:RANGE 1"
SET 	C2: RANGE 1 02.000 m/s	Press [SET] to select the desired item setting value. And the cursor disappears and the item setting value displays. You can check it.
	C2: RANGE 1 <u>0</u> 2.000 m/s	Pressing [▶], the cursor appears. Parameter changing sequence
	C2: RANGE 1 <u>1</u> 2.000 m/s	Change the value by pressing [▲].
	C2: RANGE 1 1 <u>2</u> .000 m/s	Then move the cursor to another digit by pressing [▶].
	C2: RANGE 1 0 <u>5</u> .000 m/s	Change the value by pressing [▲]. Then move the cursor to another digit by pressing [▶] and change the value. In this example repeat this process until the display shows "05.000m/s"
SET 	C2: RANGE 1 05.000 m/s	By pressig [SET], flickers the selected value to confirm changes made for the selected item.
	C2: RANGE 1 <u>0</u> 2.000 m/s	By pressing [▲], to return to the parameter changing sequence.
SET 	C2: RANGE 1 05.000 m/s	By pressing [SET], stores the indicated value and stop flickering of data.

■ To return the measurement value:

Key operation	Display example	Description
	C2: RANGE 1 0.5000 m/s	Checking the setting value or after settled the value.
SET 	C2: RANGE 1	By pressing [SET], return to the items selection sequence.
	C2: RANGE 1	Items selection sequence displays. Then move the cursor to the number by pressing [▶]. * If cursor is the number, the number is changed to the alphabet by pressing [▶].
	C3: RANGE 2	Change the alphabet to "B" by pressing [▲]. * If cursor is the number, the number is increased by pressing [▲].
 	C0: MEAS. MODE	By pressing [▶] and [▲], select "0:MEAS. MODE" The example shows "C0:MEAS. MODE"
SET 	10.00 m/s 100.0 %	Pressing [SET], returns to measurement mode.

7.3.3 Converter for Special specifications

The converter for special specifications is added some setting parameters. To differentiate the converter for special specifications and normal, remove housing cover for the terminal board shown in Figure 7.2. The converter marked as shown in Figure 7.2 is for special specifications, and non-marked is normal.

The added setting parameters are following items.

- (1) Password input/setting
- (2) 4-20mA alarm out setting
- (3) DI detective level setting
- (4) Preset function

See 8.2, "Checking or Changing Parameters" for details.

Example: F400 0112

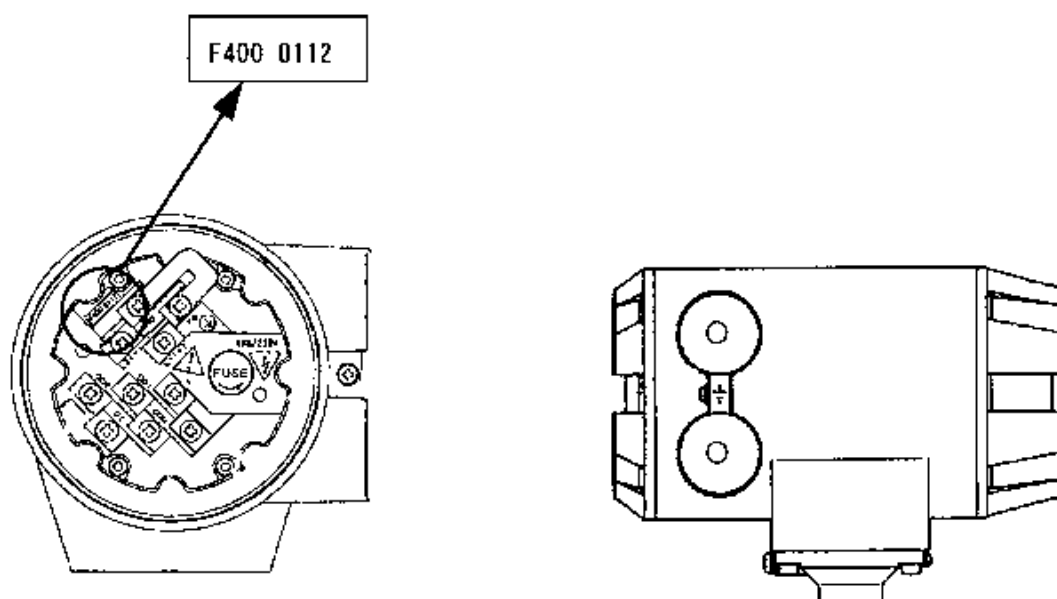

Figure 7.2 LF404 Converter for special specifications

7.4 Configuration Items Selection Table

In the setting and calibration modes, configuration items can be selected as shown below. For example, the excitation current can be selected by the item A1. To change the parameters for the selected items, see the following chapters. To return to the measurement mode, select "0" for the number (such as A0).

Setting mode items (A1, A2, A3 to M1): See Chapter 8, "Configuration Parameter Setting."

Calibration mode item (N1 to N4): See Chapter 9, "Calibration."

	0	1	2	3	4	5	6
A	*1	Excitation Current *2	Meter Size *2	Excitation Frequency *2	Password *2		
B	*1	Indicating Unit 1	Indicating Unit 2				
C	*1	Range Type *2	Range 1 *2	Range 2 *2	Range 3 *2	Range 4 *2	Range Hysteresis *2
D	*1	Damping Constant	Low Cutoff	4-20 mA Alm. Output *2			
E	*1	Zero Adjustment					
F	*1	DO1 Function *2	DO2 Function *2	DI Function *2	DO1 Alarm Active Set *2	DO2 Alarm Active Set *2	DI Det.Level *2
G	*1	Counting Rate *2	Pulse Width *2				
H	*1	Preset Count *2	Preset Funct *2				
I	*1	High Alarm Set *2	High Alarm Value *2	Low Alarm Set *2	Low Alarm Value *2		
J	*1	Empty Pipe Alarm					
K	*1	Rate-of-change Limit	Control Limit Time				
L	*1	Fixed-value Output *2	Fixed-current Output *2	Fixed-pulse Output *2			
M	*1	Zero Offset Adjustment					
N	*1	Flow Rate Cal 0% *2	Flow Rate Sig 50% *2	Flow Rate Cal 100% *2	Exciting Current Check		

*1: Returns to the measurement mode.

*2: Password-protected parameter

Note: "A4:Password", "D3:4-20Alm.Out", "F6:DI Det.Level", and "H2:Preset Funct" are added parameters in the converter for special specifications.

7.5 Password Input

Password input is added parameters in the converter for special specifications (refer to 7.3.3 "Converter for Special specifications"). Only in case of the converter for special specifications, read this section.

The converter for special specifications have the password that protects from calibrating and changing part of parameter that influences measurement..



See 7.4 "Configuration Items Selection Table" for details of password-protected parameter.

* See 8.2.17 "Password" for password setting.

*Setting '000' to the password of the normal converter (see 7.3.3 "Converter for Special specifications"), password input mode does not appear and all configuration parameter and calibrate can be changed.

■ To input password:

The following example shows how to input password ,123.

Key operation	Display example	Description
	10.00 m/s 100.0 %	Measure value displays.(Measurement mode)
SET <input type="checkbox"/>	PASSWORD INPUT 000	Pressing [SET], password input mode and the cursor appears.
 <input type="checkbox"/>	PASSWORD INPUT 100	Change the value by pressing [▲].
 <input type="checkbox"/> <input type="checkbox"/>	PASSWORD INPUT 100 120 123	Move the cursor to another digit by pressing [▶] and change the value by pressing [▲]. In this example repeat this process until the display shows "123."
SET <input type="checkbox"/>	PASSWORD INPUT 123	Pressing [SET], the cursor disappears and the changed display flickers. Press [SET] again to input the value.
SET <input type="checkbox"/>	A1: EX. CURR.	Whether input password agrees or does not agree, the items selection sequence, "A1:EX. CURR" appears. But if input password does not agree, you can not change setting parameter and calibrate. See 7.4 "Configuration Items Selection Table" for details.

8. Configuration Parameter Setting

8.1 Configuration Items

To check or change parameters, first select the desired configuration item as described in 7.3.2. The configuration items are listed below. See each section for detailed procedure.

Section	Configuration item	Display example		Page
8.2.1	Excitation Current	A1: EX. CURR.	0.2100 A	47
8.2.2	Meter Size	A2: METER SIZE	50 mm	49
8.2.3	Excitation Frequency	A3: EX. FREQ.	24 Hz	51
8.2.4	Indicating unit	B1: UNIT 1	m/s	53
8.2.5	Range Type Span (range) Hysteresis	C1: RANGE TYPE C2: RANGE 1 C6: RANGE HYST	1: SINGLE 01.000 m/s 05.0 %	57
8.2.6	Damping Constant	D1: DAMPING	05.0 s	65
8.2.7	Low Cutoff	D2: LOW CUT	05.0 %	67
8.2.8	Zero Adjustment	E1: ZERO ADJUST.	0.1 %	69
8.2.9	Digital I/O	F1: D01 FUNCT.	1: H ALM	70
8.2.10	Counting Rate Pulse Width	G1: COUNT RATE G2: PLS. WIDTH	6.00E-11 020 ms	73
8.2.11	Preset Count	H1: PRESET COUNT	00009000	76
8.2.12	High/Low Alarm Alarm Limit Value	I1: H. ALARM SET I2: H. ALARM VAL	ON +100.0 %	78
8.2.13	Empty Pipe Alarm	J1: EMPTY ALM	0:OFF	81
8.2.14	Rate-of-change Limit Control Limit Time	K1: LIMIT RATE K2: LIMIT TIME	05.5 % 01 s	84
8.2.15	Fixed-value Output	L1: FIXED OUT	OFF	87
8.2.16	Zero Offset Adjustment	M1: MANUAL ZERO	-000.1 %	91
8.2.17	Password *	A4: PASSWORD	123	93
8.2.18	4-20mA Alarm Output *	D3: 4-20 ALM. OUT	1:4.0mA	97
8.2.19	DI detective Level *	F6: DI DET. LEVEL	1: H LEVEL	99
8.2.20	Preset Function *	H2: PRESET FUNCT	0:HOLD	101

*: "A4:Password", "D3:4-20ALM.OUT", "F6:DI DET.LEVEL", and "H2:PRESET FUNCT" are added parameters in the converter for special specifications (refer to 7.3.3 "Converter for Special specifications"). The normal converter does not have these setting parameters.

8.2 Checking or Changing Parameters

8.2.1 Excitation Current

Proceed as follows to check or change the excitation current setting value.

■ To check the exciting current setting value:

Key operation	Display example	Description
SET <input type="checkbox"/>	A1: EX. CURR. 0. 2100A	Press [SET] first to start the items selection sequence and select A1: EX. CURR. from among the configuration items using [▶] and [▲] keys. Then press [SET] again to display the exciting current setting value.
SET <input type="checkbox"/>	A1: EX. CURR.	Pressing [SET], the system returns to the items selection sequence.

■ To change the excitation current setting value:

IMPORTANT

The exciting current value is factory set when shipped. Do not change the value unless the value differs from that written on the nameplate of the flowmeter.

The following example shows how to change the excitation current setting value from 0.1900A to 0.2150A.

Key operation	Display example	Description
SET <input type="checkbox"/>	A1: EX. CURR. 0. 1900A	Press [SET] first to start the items selection sequence and select A1: EX. CURR from among the configuration items using [▶] and [▲] keys. Then press [SET] again to display the excitation current setting value (0.1900 A in this example).
<input type="checkbox"/>	A1: EX. CURR. 0. <u>1</u> 900A	Pressing [▶], the cursor appears. Then press [▶] as many times as necessary to move the cursor to the digit to be changed.
<input type="checkbox"/> <input type="checkbox"/>	A1: EX. CURR. 0. <u>2</u> 900A 0. 2 <u>1</u> 00A 0. 21 <u>5</u> 0A	Change the value by pressing [▲]. Then move the cursor to another digit by pressing [▶] and change the value. In this example repeat this process until the display shows "0.2150A." (Note)
SET <input type="checkbox"/>	A1: EX. CURR. 0. 2150A	Pressing [SET], the cursor disappears and the changed display flickers. Press [SET] again to save the value.
SET <input type="checkbox"/>	<u>A</u> 1: EX. CURR.	Pressing [SET], the system returns to the items selection sequence.

Note: The valid range is from 0.0500A to 0.2300A. If you try to set the value above 0.2400A, the error message * H. OVER SPEC appears. Set the value within the valid range.

8.2.2 Meter Size

Proceed as follows to check or change the meter size of the detector.

■ To check the meter size:

Key operation	Display example	Description
SET <input type="checkbox"/>	A2: METER SIZE 50 mm	Press [SET] first to start the items selection sequence and select A2: METER SIZE from among the configuration items using [▶] and [▲] keys Then press [SET] again to display the current meter size.
SET <input type="checkbox"/>	A2: METER SIZE	Pressing [SET], the system returns to the items selection sequence.

■ To change the meter size:

IMPORTANT
 Meter size is factory set when shipped. Do not change the meter size unless it differs from the specified value.

The following example shows how to change the meter size from 50 mm to 100 mm.

Key operation	Display example	Description
SET <input type="checkbox"/>	A2: METER SIZE 50 mm	Press [SET] first to start the items selection sequence and select A2: METER SIZE from among the configuration items using [▶] and [▲] keys. Press [SET] again to display the current meter size (50 mm in this example).
<input type="checkbox"/> ▶	A2: METER SIZE 5 <u>0</u> mm	Pressing [▶], the cursor appears.
<input type="checkbox"/> ▲	A2: METER SIZE 10 <u>0</u> mm	Select "100 mm" by pressing [▲] as many times as necessary. (Note)
SET <input type="checkbox"/>	A2: METER SIZE 100 mm	Pressing [SET], the cursor disappears and the changed display flickers. Press [SET] again to save the value.
SET <input type="checkbox"/>	A2: METER SIZE	Pressing [SET], the system returns to the items selection sequence.

Note: The meter size is changed as shown below by pressing [▲].

▶ 2.5 mm 15 mm → 100 mm 600 mm → 0.1 in 0.5 in → 4 in 24 in

If the meter size has been changed, other setting values (such as span and counting rate) will be affected depending on the measuring unit used. Therefore, check those setting values if you have changed the meter size.

8.2.3 Excitation Frequency

Proceed as follows to check or change the excitation frequency.

■ To check the excitation frequency:

Key operation	Display example	Description
SET <input type="checkbox"/>	A3: EX. FREQ. 24 Hz	Press [SET] first to start the items selection sequence and select A3: EX. FREQ. from among the configuration items using [▶] and [▲] keys. Then press [SET] again to display the current excitation frequency.
SET <input type="checkbox"/>	A3: EX. FREQ.	Pressing [SET], the system returns to the items selection sequence.

■ **To change the excitation frequency:**

The excitation frequency can be selected from 6 , 12 and 24 Hz. The characteristics of the flowmeter change in accordance with the selected frequency as shown below. 24 Hz is the default setting when shipped from the factory.

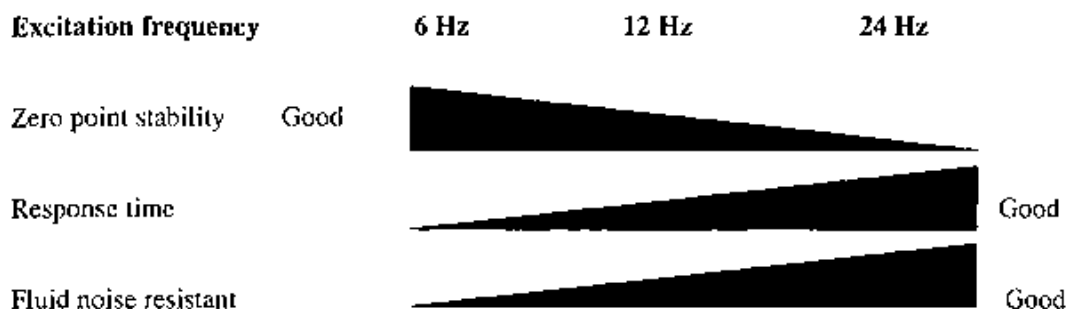

The following example shows how to change the excitation frequency from 24 Hz to 12 Hz.

Key operation	Display example	Description
SET <input type="checkbox"/>	A3: EX. FREQ. 24 Hz	Press [SET] first to start the items selection sequence and select A3: EX. FREQ. from among the configuration items using [▶] and [▲] keys. Press [SET] again to display the current excitation frequency (24 Hz in this example).
 <input type="checkbox"/>	A3: EX. FREQ. 24 Hz	Pressing [▶], the cursor appears.
 <input type="checkbox"/>	A3: EX. FREQ. 12 Hz	Select "12 Hz" by pressing [▲] twice. The excitation frequency changes as follows:
SET <input type="checkbox"/>	A3: EX. FREQ. 12 Hz	Pressing [SET], the cursor disappears and the changed display flickers. Press [SET] again to save the value.
SET <input type="checkbox"/>	A3: EX. FREQ.	Pressing [SET], the system returns to the items selection sequence.

8.2.4 Indicating Unit

You can select one of the 29 engineering units listed below as an indicating unit.

- **Flow velocity:** m/s, (ft/s)
- **Flow rate:** m³/s, m³/min, m³/h, m³/d
l/s, l/min, l/h, l/d
ml/s, ml/min, ml/h, ml/d
(bbl/s), (bbl/min), (bbl/h), (bbl/d)
(gal/s), (gal/min), (gal/h), (gal/d)
- **Volumetric flow:** m³, l, ml, (gal)
(totalized flow)
- **Other units:** %, COUNT (totalized flow without a unit), RANGE (1 to 4)
- (• **Code of volumetric**
flow direction: F(fixed forward flow), R(fixed reverse flow),
B(automatic selection bi-directional flow))

Notes

1. Units in parentheses, such as "bbl", "gal" and "ft" are shown only when the meter size is selected in inches. They are not shown when the meter size is selected in mm.
2. If COUNT or RANGE is selected, the display is shown as follows:
COUNT: displays totalized flow counts (8 digits) without a unit.
RANGE: displays the range number (1 to 4).
3. Only in case of the converter for special specifications (refer to 7.3.3 "Converter for Special specifications"),
 - Time units /d, and flow rate units bbl/s, bbl/min, bbl/h, bbl/d, bbl can be selected.
 - Code of volumetric flow direction F(fixed forward flow), R(fixed reverse flow), B(automatic selection bi-directional flow) can be selected.

Two indicating units (primary unit: UNIT 1, secondary unit: UNIT 2) can be selected.

Proceed as follows to check or change these two indicating units.

■ To check the indicating units:







Key operation	Display example	Description
SET <input type="checkbox"/>	B1: UNIT 1 %	Press [SET] first to start the items selection sequence and select B1: UNIT 1 from among the configuration items using [▶] and [▲] keys. Then press [SET] again to display the current primary indicating unit .
SET <input type="checkbox"/>	<u>B</u> 1: UNIT 1	Pressing [SET], the system returns to the items selection sequence.

Primary indicating unit and secondary indicating unit can be selected by the following configuration items:

- B1: UNIT 1 primary indicating unit
- B2: UNIT 2 secondary indicating unit

■ To change the indicating unit (1):

The following example shows how to change the primary indicating unit from % to ml/s.

Key operation	Display example	Description
SET 	B1: UNIT 1 %	Press [SET] first to start the items selection sequence to select B1: UNIT 1 from among the configuration items using [▶] and [▲] keys Then press [SET] again to display the current primary indicating unit (% in this example).
	B1: UNIT 1 %	Pressing [▶], the cursor appears.
	B1: UNIT 1 ml B	Select "ml" as the first unit of primary indicating unit by pressing [▲] as many times as necessary. (Note1)
	B1: UNIT 1 ml _ B	Pressing [▶], the cursor moves to the second unit (time unit) of primary indicating unit.
	B1: UNIT 1 ml/s	Select "s" as the second unit (time unit) of primary indicating unit by pressing [▲] as many times as necessary. (Note 2)
SET 	B1: UNIT 1 ml/s	Pressing [SET], the cursor disappears and the changed display flickers. Press [SET] again to save the unit.
SET 	B1: UNIT 1	Pressing [SET], the system returns to the item selection sequence.

Notes:1.The first unit (volumetric units etc.) changes as shown below:

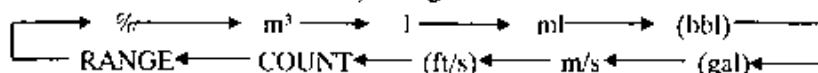

Units in parentheses, such as "bbl", "gal" and "ft" are shown only when the meter size is selected in inches. They are not shown when the meter size is selected in mm.

2. The second unit (time unit) changes as shown below:

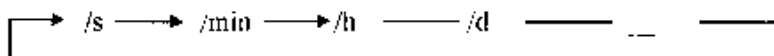

■ To change the indicating unit (2):

Only in case of the converter for special specifications (refer to 7.3.3 “Converter for Special specifications”), Code of volumetric flow direction F(fixed forward flow), R(fixed reverse flow), B(automatic selection bi-directional flow) can be selected. In case of normal converter, the code of volumetric flow direction does not appear.

The following example shows how to change the primary indicating unit from m³ F to m³ R.

Key operation	Display example	Description
SET <input type="checkbox"/>	B1: UNIT 1 m ³ F	Press [SET] first to start the items selection sequence to select B1: UNIT 1 from among the configuration items using [▶] and [▲] keys Then press [SET] again to display the current primary indicating unit (m ³ F in this example).
<input type="checkbox"/>	B1: UNIT 1 <u>m³ F </u>	Pressing [▶], the cursor appears.
<input type="checkbox"/>	B1: UNIT 1 m ³ <u>_</u> F	Pressing [▶], the cursor moves to the second unit (time unit) of primary indicating unit.
<input type="checkbox"/>	B1: UNIT 1 m ³ <u>F</u>	Pressing [▶], the cursor moves to the third unit (code of volumetric flow direction) of primary indicating unit.
<input type="checkbox"/>	B1: UNIT 1 m ³ <u>R</u>	Select “R” as the third unit (code of volumetric flow direction) of primary indicating unit by pressing [▲] as many times as necessary. (Note 1)
SET <input type="checkbox"/>	B1: UNIT 1 m ³ R	Pressing [SET], the cursor disappears and the changed display flickers. Press [SET] again to save the unit.
SET <input type="checkbox"/>	B1: UNIT 1	Pressing [SET], the system returns to the item selection sequence.

Notes. The third unit (code of volumetric flow direction) changes as shown below:

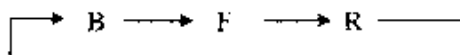

8.2.5 Span (range)

You can set the following constants in this setting item:

- (1). Range type
- (2). Span
- (3). Unit of span (can be changed only in range 1)
- (4). Hysteresis

(1) Range type

You can select a single range or multiple ranges. Select one from five types shown below:

Range type	Description
1. SINGLE	Single range
2. 4F-0R	Unidirectional flow, automatic selection of multiple ranges
3. 2F-2R	Bidirectional flows, automatic selection of multiple ranges
4. EXT. 2F-0R	Unidirectional flow, multiple ranges selected by external signal
5. EXT. 2F-2R	Bidirectional flows, multiple ranges selected by external signal

(2) Span (range)

■ Span can be set and displayed as follows for flow velocity and flow rates:

- Flow velocity: 01.000 m/s (three digits after the decimal point)
- Flow rates: 2.83E+3 m³/H (three digits and exponential)

■ Valid range of span is 0.1 m/s to 10 m/s in terms of flow velocity.

If you try to set the span outside of this range, one of the following messages appears:

- * H. OVER SPEC. (if the set value exceeds 10 m/s)
- * L. OVER SPEC. (if the set value is less than 0.1 m/s)

Try again to set the span within the specified range.

■ When multiple ranges are used, the following must be observed:

- Range 1 > Range 2 > Range 3 > Range 4 (unidirectional flow, multiple ranges)
- Range 1 > Range 2, Range 3 > Range 4 (bidirectional flows, multiple ranges)

If you try to set the ranges not conforming to the above, the following message appears:

- * MULTI RNG ERR

Try again to set the ranges as specified above.

■ Totalization counting rate

If you have changed the span while the counting rate is set for totalization, the counting rate for 100% output may have exceeded the maximum counting capacity. In this kind of event, the following message appears and the system goes to the counting rate setting sequence.

- * H. OVER C RATE or L. OVER C RATE

Set the counting rate (See 8.2.10 "Counting Rate") for the newly set span.

(3) Unit of span

One of the following engineering units as a unit for the span can be selected. The unit is set for the range 1 and the same unit applies automatically to other ranges—range 2, range 3 and range 4.

- **Flow velocity:** m/s, (ft/s)
- **Flow rate:** m³/s, m³/min, m³/h, m³/d
l/s, l/min, l/h, l/d
ml/s, ml/min, ml/h, ml/d
(bbl/s), (bbl/min), (bbl/h), (bbl/d)
(gal/s), (gal/min), (gal/h), (gal/d)

Units in parentheses, such as “bbl”, “gal” and “ft” are shown only when the meter size is selected in inches. They are not shown when the meter size is selected in mm.

If you change the unit, the new span based on the newly set unit will be automatically displayed.

Only in case of the converter for special specifications (refer to 7.3.3 “Converter for Special specifications”), Time units /d, and flow rate units bbl/s, bbl/min, bbl/h, bbl/d, bbl can be selected.

(4) Hysteresis

The hysteresis is the dead band used when multiple ranges are switched. The hysteresis can be set from 0 to 25% in increments of 0.1%. The hysteresis setting is needed only when automatic selection of multiple ranges is used.

[The setting sequence]

The following is the setting sequence of span (range).

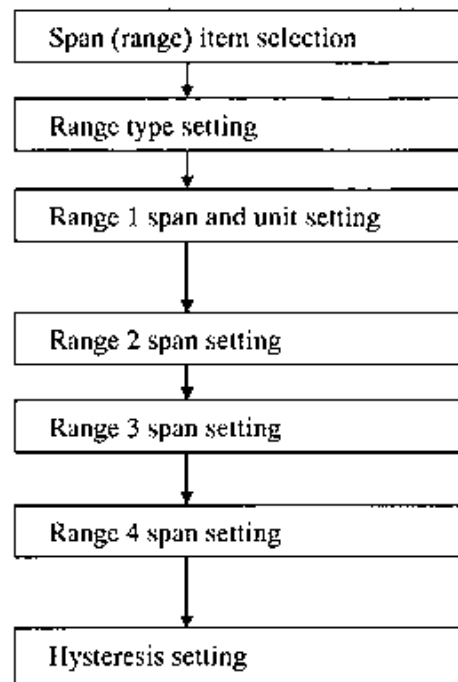

If multiple range is selected, compulsory range 1 to range 4 and hysteresis settings are displayed.

Proceed as follows to check or change each constant.

■ To check each constant:

Key operation	Display example	Description
SET <input type="checkbox"/>	C2: RANGE 1 02.000 m/s	Press [SET] first to start the items selection sequence and select C2: RANGE 1 from among the configuration items using [▶] and [▲] keys. Then press [SET] again to display the current span for Range 1.
SET <input type="checkbox"/>	C2: RANGE 1	Pressing [SET], the system returns to the items selection sequence.

Range type, Span, Hysteresis can be selected by the configuration items as follows:

Range type	C1: RANGE TYPE
Span of Range 1	C2: RANGE 1
Span of Range 2	C3: RANGE 2
Span of Range 3	C4: RANGE 3
Span of Range 4	C5: RANGE 4
Hysteresis	C6: RANGE HYST

■ To change the range type:

Range type should be changed before changing the span.

The following example shows how to change the range type from 1 to 3.

Key operation	Display example	Description
SET <input type="checkbox"/>	C1: RANGE TYPE 1: SINGLE	Press [SET] first to start the items selection sequence and select C1: RANGETYPE from among the configuration items using [▶] and [▲] keys. Then press [SET] again to display the current range type.
<input type="checkbox"/>	C1: RANGE TYPE <u>1</u> : SINGLE	Pressing [▶], the cursor appears.
<input type="checkbox"/>	C1: RANGE TYPE <u>3</u> : 2F-2R	Select Range type 3 (3: 2F-2R) by pressing [▲] twice.
SET <input type="checkbox"/>	C1: RANGE TYPE 3: 2F-2R	Pressing [SET], the cursor disappears and the changed display flickers. Press [SET] again to store the changed type.
SET <input type="checkbox"/>	<u>C</u> 1: RANGE TYPE	Pressing [SET], the system returns to the items selection sequence.

■ To change the span (range):

The following example shows how to change the span of Range 1 from 2.0 m/s to 100 l/min.

Key operation	Display example	Description
SET <input type="checkbox"/>	C2: RANGE 1 02.000 m/s	Press [SET] first to start the items selection sequence and select C2: RANGE 1 from among the configuration items using [▶] and [▲] keys. Then press [SET] again to display the current span of Range 1 (2.0 m/s in this example).
<input type="checkbox"/>	C2: RANGE 1 02.000 m/s	Pressing [▶], the cursor appears. Then press [▶] as many times as necessary to move the cursor to the position for the measuring unit.
<input type="checkbox"/>	C2: RANGE 1 3.93E+0 l/s 2.36E+2 l/min	Select "l" as the first unit of the measuring unit by pressing [▲] as many times as necessary. (Note 1) Similarly, pressing [▶] to move the cursor to the second unit (time unit), select "min." (Note 2) (The displayed span automatically changes in accordance with the newly selected unit.)
<input type="checkbox"/>	C2: RANGE 1 2.36E+2 l/min	Press [▶] as many times as necessary to move the cursor to the digit of span to be changed.
<input type="checkbox"/>	C2: RANGE 1 1.36E+2 l/min 1.00E+2 l/min	Change the value by pressing [▲]. Then move the cursor to another digit by pressing [▶] and change the value. In this example repeat this process until the display shows "1.00E+2" (=100) l/m.
SET <input type="checkbox"/>	C2: RANGE 1 1.00E+2 l/min	Pressing [SET], the cursor disappears and the changed display flickers. Press [SET] again to store the changed span and unit.
SET <input type="checkbox"/>	C2: RANGE 1	Pressing [SET], the system returns to the items selection sequence.

Notes 1. The first unit of the measuring unit changes as shown below:

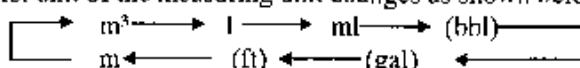

Units in parentheses (bbl, ft and gal) are shown only when the meter size is selected in inches.

2. The second unit of the measuring unit changes as shown below:

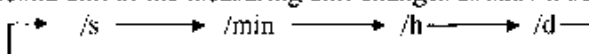

However, the following first and second unit combinations cannot be selected: m/min, m/h, m/d, ft/min, ft/h, ft/d.

■ To change the hysteresis:

The hysteresis is set at 3% (default) when shipped from the factory.

The following example shows how to change the hysteresis from 3% to 5%.

Key operation	Display example	Description
SET <input type="checkbox"/>	C6: RANGE HYST 03.0 %	Press [SET] first to start the items selection sequence and select C6: RANGE HYST from among the configuration items using [▶] and [▲] keys. Then press [SET] again to display the current hysteresis (3.0% in this example).
<input type="checkbox"/> ▶	C6: RANGE HYST 0 <u>3</u> .0 %	Pressing [▶], the cursor appears.
<input type="checkbox"/> ▶	C6: RANGE HYST 0 <u>3</u> .0 %	Press [▶] to move the cursor to the desired digit to change.
<input type="checkbox"/> ▲	C6: RANGE HYST 0 <u>5</u> .0 %	Change the value to "5" by pressing [▲] twice. (if necessary, move the cursor to another digit and change the value).(Note)
SET <input type="checkbox"/>	C6: RANGE HYST 05.0 %	Pressing [SET], the cursor disappears and the changed display flickers. Press [SET] again to store the changed hysteresis.
SET <input type="checkbox"/>	C6: RANGE HYST	Pressing [SET], the system returns to the item selection sequence.

Note: If you try to set the hysteresis above 25.0 %, an error message "* H. OVER SPEC." appears. Try again to set the value within the specified range.

8.2.6 Damping Constant

The damping constant is used to moderate output fluctuations. (The larger the damping constant, the more the output is averaged. But the response to an input change will be slower.) The damping constant can be set as follows:

0.0 sec, 0.5 sec and 1 to 60 sec (in increments of 1 second)

Note: 0.0 sec setting will work as equal to 0.1 sec damping constant.

Setting value exceeding 60 sec will be automatically set to 60 sec.

Proceed as follows to check or change the damping constant.

■ To check the damping constant:

Key operation	Display example	Description
SET <input type="checkbox"/>	D1: DAMPING 02.0 s	Press [SET] first to start the items selection sequence and select D1: DAMPING from among the configuration items using [▶] and [▲] keys. Then press [SET] again to display the current damping constant.
SET <input type="checkbox"/>	<u>D</u> 1: DAMPING	Pressing [SET], the system returns to the items selection sequence.

■ To change the damping constant:

The following example shows how to change the damping constant from 0.5 sec to 10 sec.

Key operation	Display example	Description
SET <input type="checkbox"/>	D1: DAMPING 00.5 s	Press [SET] first to start the items selection sequence and select D1: DAMPING from among the configuration items using [▶] and [▲] keys. Then press [SET] again to display the current damping constant (0.5 s).
▶ <input type="checkbox"/>	D1: DAMPING <u>0</u> 0.5 s	Pressing [▶], the cursor appears. (If necessary, press [▶] to move the cursor to the digit to be changed.)
▲ <input type="checkbox"/>	D1: DAMPING 10.5 s 10. <u>0</u> s	Change the value to "1" by pressing [▲]. Then move the cursor to another digit by pressing [▶] and change the value. In this example repeat this process until the display shows "10.0 s." (Note)
SET <input type="checkbox"/>	D1: DAMPING 10.0 s	Pressing [SET], the cursor disappears and the changed display flickers. Press [SET] again to store this data.
SET <input type="checkbox"/>	<u>D</u> 1: DAMPING	Pressing [SET], the system returns to the items selection sequence.

8.2.7 Low Cutoff

The low cutoff is the value set just above 0% flow rate. Flow rates below this level are treated as 0% and subsequent outputs as 0% current output. The low cutoff can be set from 0 to 10% of the span and in increments of 0.1%.

Proceed as follows to check or change the low cutoff value.

■ To check the low cutoff value:

Key operation	Display example	Description
SET <input type="checkbox"/>	D2: LOW CUT 01.0 %	Press [SET] first to start the items selection sequence to select D2: LOW CUT from among the configuration items using [▶] and [▲] keys. Press [SET] again to display the current low cutoff value.
SET <input type="checkbox"/>	D2: LOW CUT	Pressing [SET], the system returns to the items selection sequence.

■ To change the low cutoff value:

The following example shows how to change the low cutoff value from 1.0 % to 3.0 %.

Key operation	Display example	Description
SET <input type="checkbox"/>	D2: LOW CUT 01.0 %	Press [SET] first to start the items selection sequence and select D2: LOW CUT from among the configuration items using [▶] and [▲] keys. Press [SET] again to display the current low cutoff value (1.0% in this example).
▶ <input type="checkbox"/>	D2: LOW CUT 0 <u>1</u> .0 %	Pressing [▶], the cursor appears. Then press [▶] to move the cursor to the digit to be changed.
▲ <input type="checkbox"/>	D2: LOW CUT 0 <u>3</u> .0 %	Change the value to "3" by pressing [▲] twice. (Note) (If necessary, move the cursor to another digit by pressing [▶] and change the value.)
SET <input type="checkbox"/>	D2: LOW CUT 03.0 %	Pressing [SET], the cursor disappears and the changed display flickers. Press [SET] again to store the value.
SET <input type="checkbox"/>	D2: LOW CUT	Pressing [SET], the system returns to the items selection sequence.

Note: If you try to set the low cutoff value above 10 % of the span, an error message

* H. OVER SPEC appears. Set the value within the specified range.

8.2.8 Zero Adjustment

To conduct the zero adjustment of the flowmeter, the fluid in the detector pipe must be held still. (If the fluid cannot be stilled by any means, see 8.2.16, "Zero Offset Adjustment.")

To start the zero adjustment, follow the procedure described below.

The zero adjustment for models without LCD display can be conducted with the switch in the converter. See 6.2, "Zero Adjustment" for details.

Key operation	Display example	Description
SET <input type="checkbox"/>	E1: ZERO DJUST 01.0 %	Press [SET] first to start the items selection sequence and select E1: ZERO ADJUST from among the configuration items using [▶] and [▲] keys. Then press [SET] again to display the current flow rate (1.0% in this example).
▶ <input type="checkbox"/>	ADJUST READY 01.1 %	Pressing [▶], "ADJUST READY" appears as shown left and the system is ready for zero adjustment. (Note 1)
SET <input type="checkbox"/>	* ZERO ADJUST	Pressing [SET], "* ZERO ADJUST" appears as shown left and the system starts the zero adjustment. The zero adjustment takes about 3 to 6 seconds. (Note 2)
_____	E1: ZERO ADJUST 00.0 %	Newly adjusted zero point appears.
SET <input type="checkbox"/>	E1: ZERO ADJUST	Pressing [SET], the system returns to the items selection sequence.

Notes

1. To cancel the zero adjustment, press [▲]. The system returns to the point where zero point is displayed.
2. Zero adjustment duration depends on the excitation frequency (24 Hz: 3 sec, 12 Hz and 6 Hz: 6 sec).

8.2.9 Digital I/O

You can select the various digital I/O functions shown below. See Chapter 10, "Digital I/O Functions." for details.

■ Digital Output Functions (DO1 is standard and DO2 is optional)

DO1, DO2 items	Digital output functions
0: NO USE	Not used
1: H ALM	High limit alarm output
2: L ALM	Low limit alarm output
3: EMPTY ALM	Empty pipe alarm output
4: RNG SIG 1	Multi-range output No. 1
5: RNG SIG 2	Multi-range output No. 2
6: PRESET	Preset point output
7: CONV. ALM	Converter failure alarm output
8: PULSE OUT	Pulse output (automatic selection bi-directional flow) (Note 1)
9: PULSE OUT FRD.	Pulse output (fixed forward flow) (Note 1)
A: PULSE OUT REV.	Pulse output (fixed reverse flow) (Note 1)

Note 1: Pulse output can be chosen only for DO1(8:PULSE OUT).

In case of the converter for special specifications (refer to 7.3.3 "Converter for Special specifications"), not only 8:PULSE OUT, but also 9:PULSE OUT FRD. and A:PULSE OUT REV can be selected.

■ Digital Input Function (optional)

DI function	Digital input function
0: NO USE	Not used
1: C STA/STP	Totalizer Start/Stop
2: C RES/STA	Totalizer Reset/Start
3: RANGE SW	Remote selection of multi-range
4: ZERO ADJ.	Zero adjustment start
5: FIXED OUT	Fixed-value output control

■ Digital Output Active Status (Only for Alarm outputs)

DO1, DO2 Items	Output Action
0: NORMAL CLOSE	Normal; contact close, Alarm out; contact open (Note 2)
1: NORMAL OPEN	Normal; contact open, Alarm out; contact close (Note 2)

Note 2: The contacts of Digital outputs are open while the power supply to the converter is off.

■ Digital Input Detective Level (Only for Counter Control)

In case of the converter for special specifications (refer to 7.3.3 “Converter for Special specifications”), Digital Input Detective Level (Only for Counter Control) can be selected. For detail, see 8.2.19 “Digital Input Detective Level”.

Proceed as follows to check or change the digital I/O functions.

■ To check the digital I/O functions:

Key operation	Display example	Description
SET <input type="checkbox"/>	F1: DO1 FUNCT. 1:H ALM	Press [SET] first to start the items selection sequence and select F1: DO1 FUNCT. from among the configuration items using [▶] and [▲] keys. Then press [SET] again to display the current DO1 function.
SET <input type="checkbox"/>	F1: DO1 FUNCT.	Pressing [SET], the system returns to the items selection sequence.

Digital output 1 (DO1), digital output 2 (DO2) and digital input (DI) can be selected by the configuration items as follows:

Digital output 1 (DO1)	F1: DO1 FUNCT.
Digital output 2 (DO2)	F2: DO2 FUNCT.
Digital input (DI)	F3: DI FUNCT.
Active status of DO1	F4: DO1 ALM ACT.
Active status of DO2	F5: DO2 ALM ACT.

The active status of Digital output can be selected from Normal Open and Normal Close for Alarm outputs which are the Converter alarm, the High/Low limit alarm and the Empty alarm. If the function except these alarms is selected as DO1 or DO2 function, the active status is ignored.

■ To change the digital I/O functions:

The following example shows how to change the DO1 function from No. 1 to No. 3.

Key operation	Display example	Description
SET <input type="checkbox"/>	F1: DO1 FUNCT. 1:H ALM	Press [SET] first to start the items selection sequence and select F1: DO1 FUNCT. from among the configuration items using [▶] and [▲] keys. Then press [SET] again to display the current DO1 function (1: H ALM in this example).
▶ <input type="checkbox"/>	F1: DO1 FUNCT. <u>1</u> :H ALM	Pressing [▶], the cursor appears.
▲ <input type="checkbox"/>	F1: DO1 FUNCT. <u>3</u> :EMPTY ALM	Change the value to "3" by pressing [▲] twice.
SET <input type="checkbox"/>	F1: DO1 FUNCT. 3:EMPTY ALM	Pressing [SET], the cursor disappears and the new DO1 function display flickers. Press [SET] again to save the new function.
SET <input type="checkbox"/>	F1: DO1 FUNCT.	Pressing [SET], the system returns to the items selection sequence.

8.2.10 Counting Rate (pulse rate)

When the totalizer is used for total flow measurement, per-count (pulse) value is the counting rate. Pulse output is also available for external totalization. In this item, the counting rate and the pulse width for pulse output can be checked or changed. The counting rate is set using three digits and exponential quotient.

For example, 0.123 m^3 \rightarrow $1.23\text{E}-1 \text{ m}^3$
 $(1.23 \times 10^{-1} \text{ m}^3)$

Proceed as follows to check or change the counting rate.

■ To check the counting rate and pulse width:

Key operation	Display example	Description
SET <input type="checkbox"/>	G1: COUNT RATE 1.00E-2m ³	Press [SET] first to start the items selection sequence and select G1:COUNTRATE from among the configuration items using [▶] and [▲] keys. Then press [SET] again to display the current counting rate.
SET <input type="checkbox"/>	G1: COUNT RATE	Pressing [SET], the system returns to the items selection sequence.

Counting rate and pulse width can be selected by the configuration items as follows:

Counting rate G1: COUNT RATE

Pulse width G2: PLS. WIDTH

NOTES

- The counting rate should be set so that its rate for 100% flow rate output is within the range from 3.6 to 3600000 pulses/h. If you try to set the counting rate outside of this range, an error message * H. OVER SPEC or * L. OVER SPEC appears.

Set the counting rate within the specified range.

Example

Case Range:3600m³/h (1m³/s)

Counting rate(pulse rate)

Min.: 3600(m³/h) / 3600000(pulses/h) =0.001 m³=1 l

Max.: 3600(m³/h) / 3.6(pulses/h) =1000 m³

2. The pulse width can be set from 0.5ms to 500ms. The pulse width should be set to less than half of the pulse rate for 100% flow rate output. Even if the value over 500ms is inputted, the pulse width is set to 500ms. When the pulse width is set to 0 (zero), it will be automatically set to half of the pulse rate for 100% flow rate output. If this calculated value is over 100ms, the pulse width is set to 100ms.

Example1

Case Range :3600m³/h (1m³/s)
 Counting rate(pulse rate) :0.001m³

the pulse rate for 100% flow rate

$$: 3600(\text{m}^3/\text{h}) / 0.001(\text{m}^3) = 3600000 \text{ pulses/h} = 1000 \text{ pulses/p}$$

the pulse rate= 1ms

$$* \text{the pulse width(Max.)} = 1\text{ms} / 2 = 0.5\text{ms}$$

Example2

Case Range :3600m³/h (1m³/s)
 Counting rate(pulse rate) :1000m³

the pulse rate for 100% flow rate

$$: 3600(\text{m}^3/\text{h}) / 1000(\text{m}^3) = 3.6 \text{ pulses/h} = 0.001 \text{ pulses/p}$$

the pulse rate= 1000000ms

$$\text{the pulse width(Max.)} = 1000000\text{ms} / 2 = 500000\text{ms}$$

but, the pulse width is 500ms Max.

$$* \text{the pulse width(Max.)} = 500\text{ms}$$

Example3

Case Range :3600m³/h (1m³/s)
 Counting rate(pulse rate) :1m³
 Setting pulse width :0ms (automatically set)

the pulse rate for 100% flow rate

$$: 3600(\text{m}^3/\text{h}) / 1(\text{m}^3) = 3600 \text{ pulses/h} = 1 \text{ pulses/p}$$

the pulse rate= 1000ms

$$\text{the pulse width(Max.)} = 1000\text{ms} / 2 = 500\text{ms}$$

but, the pulse width that automatically set is 100ms Max.

$$* \text{the pulse width (Max.)} = 100\text{ms}$$

3. To operate the totalizer, it is preferable to set the indicating unit (UNIT1 and/or UNIT 2) to one of the units appropriate for totalization just to make sure it is operating correctly.

■ **To change the counting rate:**

The following example shows how to change the counting rate from 0.01 m³ to 0.9 l.

Key operation	Display example	Description
SET <input type="checkbox"/>	G1: COUNT RATE 1.00E-2m ³	Press [SET] first to start the items selection sequence and select G1: COUNT RATE from among the configuration items using [▶] and [▲] keys. Then press [SET] again to display the current counting rate (1.00E-2m ³ = 0.01 m ³).
<input type="checkbox"/> ▶	G1: COUNT RATE <u>1</u> .00E-2m ³	Pressing [▶], the cursor appears. Then press [▶] as many times as necessary to move the cursor to of measuring unit.
<input type="checkbox"/> ▲	G1: COUNT RATE 1.00E-2 <u>l</u> 9.00E-1 <u>l</u>	Select "l" as the measuring unit by pressing [▲]. (Note) Then move the cursor to the desired digit by pressing [▶] and change the value. In this example repeat this process until the display shows "9.00E-1l."
SET <input type="checkbox"/>	G1: COUNT RATE 9.00E-1l	Pressing [SET], the cursor disappears and the new counting rate display flickers. Press [SET] again to store the new counting rate.
SET <input type="checkbox"/>	G1: COUNT RATE	Pressing [SET], the system returns to the items selection sequence.

Note: The unit changes as shown below by pressing [▲].

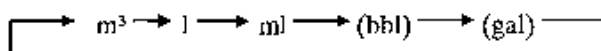

In case of the converter for special specifications (refer to 7.3.3 "Converter for Special specifications"), "bbl" can be selected.

The unit in parentheses (bbl), (gal) is shown only when the meter size is selected in inches.

8.2.11 Preset Count Value

The preset count value is used to preset the totalizer. The preset count value can be set from 0 to 99999999.

NOTE

Totalizer counting is effective only for the specified direction flow.

To operate the totalizer, it is preferable to set the indicating unit (UNIT 1 and/or UNIT 2) to one of the units appropriate for totalization just to make sure it is operating correctly.

In case of the converter for special specifications (refer to 7.3.3 "Converter for Special specifications"), you can select Preset Function. For detail, see 8.2.20 "Preset Function".



Proceed as follows to check or change the preset count value.

■ To check the preset count value:

Key operation	Display example	Description
SET <input type="checkbox"/>	H1: PRESET 00000300	Press [SET] first to start the items selection sequence and select H1: PRESET from among the configuration items using [▶] and [▲] keys. Then press [SET] again to display the preset count value.
SET <input type="checkbox"/>	H1: PRESET	Pressing [SET], the system returns to the items selection sequence.

■ To change the preset count value:

The following example shows how to change the preset count value from 500 to 1000.

Key operation	Display example	Description
SET <input type="checkbox"/>	H1: PRESET 0000500	Press [SET] first to start the items selection sequence and select H1: PRESET from among the configuration items using [▶] and [▲] keys. Then press [SET] again to display the preset count value (500 in this example).
 <input type="checkbox"/>	H1: PRESET 0000 <u>5</u> 00	Pressing [▶], the cursor appears. Then press [▶] as many times as necessary to move the cursor to the desired digit to be changed.
 <input type="checkbox"/>	H1: PRESET 0000 <u>1</u> 500 0000 <u>1</u> 000	Change the value by pressing [▲]. Then move the cursor to another digit by pressing [▶] and change the value. In this example repeat this process until the display shows "1000."
SET <input type="checkbox"/>	H1: PRESET 00001000	Pressing [SET], the cursor disappears and the new preset count value display flickers. Press [SET] again to save the new preset count value.
SET <input type="checkbox"/>	H1: PRESET	Pressing [SET], the system returns to the items selection sequence.

8.2.12 High and Low Limit Alarms

The high and low limit alarms can be set to output an alarm signal when the flow rate exceeds the high or low limit set value. When this alarm occurs, a H. ALARM or L. ALARM message appears. This high and low limit alarm function can each be enabled or disabled in this item. The high and low limit values can be set from -10% to 110% of the span of the range (Range 1) in increments of 0.5%.

Proceed as follows to check or change the high and low limit values.

■ To check the high and low limit values:

Key operation	Display example	Description
SET <input type="checkbox"/>	11: H. ALARM SET ON	Press [SET] first to start the items selection sequence and select 11: H ALARM SET from among the configuration items using [▶] and [▲] keys. Then press [SET] again to display the high limit alarm enable/disable status.
SET <input type="checkbox"/>	11: H. ALARM SET	Pressing [SET], the system returns to the items selection sequence.

High/low limit alarm enable/disable status and high/low limit value can be selected by the configuration items as follows:

High limit alarm enable/disable status	11: H. ALARM SET
High limit value	12: H. ALARM VAL
Low limit alarm enable/disable status	13: L. ALARM SET
Low limit value	14: L. ALARM VAL

■ To change the high/low limit alarm status and its alarm limit value:

The following example shows how to change the high limit alarm enable/disable status from OFF to ON and change the high limit value from +100 % to +105 %.



Key operation	Display example	Description
SET <input type="checkbox"/>	I1: H. ALARM SET OFF	Press [SET] first to start the items selection sequence and select II: H. ALARM SET from among the configuration items using [▶] and [▲] keys. Then press [SET] again to display the high limit alarm enable/disable status (OFF at this point).
▶ <input type="checkbox"/>	I1: H. ALARM SET OFF	Pressing [▶], the cursor appears.
▲ <input type="checkbox"/>	I1: H. ALARM SET ON	Change the status by pressing [▲]. (Note 1)
SET <input type="checkbox"/>	I2: H. ALARM VAL +100.0%	Pressing [SET], the cursor disappears and the changed status flickers. Press [SET] again to save the status. Then the system goes to the item I2: H. ALARM VAL , and displays the current high limit value (+100.0%).
▶ <input type="checkbox"/>	I2: H. ALARM VAL +100.0%	Move the cursor to the digit to be changed.
▲ <input type="checkbox"/>	I2: H. ALARM VAL +105.0%	Change the value to "5" by pressing [▲] five times. (Note 2) (If necessary, move the cursor to another digit by pressing [▶] and change the value.)
SET <input type="checkbox"/>	I2: H. ALARM VAL +105.0%	Pressing [SET], the cursor disappears and the changed high limit value display flickers. Press [SET] again to save the value.
SET <input type="checkbox"/>	I2: H. ALARM VAL	Pressing [SET], the system returns to the items selection sequence.

Notes:

1. If the high limit alarm enable/disable status is set to OFF, the subsequent high limit value setting sequence will not come out.
2. If you try to set the value above +110% or below -10% of the span, the error messages *H. OVER SPEC or *L. OVER SPEC, respectively, appear. Set the high or low limit value within the specified range.

■ To change the high/low limit value:

The following example shows how to change the high limit value from +105 % to +103 %.

Key operation	Display example	Description
SET <input type="checkbox"/>	[2: H. ALARM VAL +105.0%	Press [SET] first to start the items selection sequence and select I2: H. ALARM VAL from among the configuration items using [▶] and [▲] keys. Then press [SET] again to display the current high limit value (+105.0% in this example).
 <input type="checkbox"/>	[2: H. ALARM VAL ±105.0%	Pressing [▶], the cursor appears. Then press [▶] as many times as necessary to move the cursor to the digit to be changed.
 <input type="checkbox"/>	[2: H. ALARM VAL +10 <u>3</u> .0%	Change the value to "3" by pressing [▲] as many times as necessary. (Note) (If necessary, move the cursor to another digit by pressing [▶] and change the value.)
SET <input type="checkbox"/>	[2: H. ALARM VAL +103.0%	Pressing [SET], the cursor disappears and the changed high limit value display flickers. Press [SET] again to save the value.
SET <input type="checkbox"/>	[2: H. ALARM VAL	Pressing [SET], the system returns to the items selection sequence.

Note: If you try to set the value above +110% or below -10% of the span, the error messages *H. OVER SPEC or *L. OVER SPEC, respectively appear. Set the high limit value within the specified range.

8.2.13 Empty Pipe Alarm

The empty pipe alarm is used to notify that the detector pipe is not filled with fluid. If an empty pipe condition occurs, a message * EMPTY appears. You can enable or disable this function here.

In case of the converter for special specifications (refer to 7.3.3 “Converter for Special specifications”), you can select Empty Pipe Alarm setting OFF, ON LEVEL1, ON LEVEL2, or ON LEVEL3.

■ Empty Pipe Alarm Functions

Empty pipe alarm	Function
0: OFF	Disable empty pipe alarm
1: ON LEVEL1	Enable empty pipe alarm (detective level high)
2: ON LEVEL2	Enable empty pipe alarm (detective level middle)
3: ON LEVEL3	Enable empty pipe alarm (detective level low)

NOTE: Setting enable empty pipe alarm, normally select “1:ON LEVEL1”.

In case of difficult condition to detect empty pipe alarm, select “2:ON LEVEL2” or “3:ON LEVEL3”.

Proceed as follows to check or change the empty pipe alarm enable/disable status.

■ To check the empty pipe alarm enable/disable status:

Key operation	Display example	Description
SET <input type="checkbox"/>	J1: EMPTY ALM ON	Press [SET] first to start the items selection sequence and select J1: EMPTY ALM from among the configuration items using [▶] and [▲] keys. Then press [SET] again to display the current empty pipe alarm enable/disable status.
SET <input type="checkbox"/>	J1: EMPTY ALM	Pressing [SET], the system returns to the items selection sequence.

- To change the empty pipe alarm enable/disable status
(Normal Converter):

The following example shows how to change the empty pipe alarm enable status.

Key operation	Display example	Description
SET <input type="checkbox"/>	J1: EMPTY ALM ON	Press [SET] first to start the items selection sequence and select J1: EMPTY ALM from among the configuration items using [▶] and [▲] keys. Then press [SET] again to display the current empty pipe alarm enable/disable status. (In this example ON will be displayed.)
<input type="checkbox"/>	J1: EMPTY ALM ON	Pressing [▶], the cursor appears.
<input type="checkbox"/>	J1: EMPTY ALM OFF	Select "OFF" by pressing [▲].
SET <input type="checkbox"/>	J1: EMPTY ALM OFF	Pressing [SET], the cursor disappears and the selected status display flickers. Press [SET] again to save the status.
SET <input type="checkbox"/>	J1: EMPTY ALM	Pressing [SET], the system returns to the items selection sequence.

- To change the empty pipe alarm enable/disable status
(Converter for Special specifications):

The following example shows how to change empty alarm from NO.1 to NO.0.

Key operation	Display example	Description
SET <input type="checkbox"/>	J1: EMPTY ALM 1:ON LEVEL1	Press [SET] first to start the items selection sequence and select J1: EMPTY ALM from among the configuration items using [▶] and [▲] keys. Then press [SET] again to display the current empty pipe alarm enable/disable status. (In this example ON LEVEL1 will be displayed.)
<input type="checkbox"/>	J1: EMPTY ALM 1:ON LEVEL1	Pressing [▶], the cursor appears.
<input type="checkbox"/>	J1: EMPTY ALM 0:OFF	Select "0:OFF" by pressing [▲].
SET <input type="checkbox"/>	J1: EMPTY ALM 0:OFF	Pressing [SET], the cursor disappears and the selected status display flickers. Press [SET] again to save the status.
SET <input type="checkbox"/>	J1: EMPTY ALM	Pressing [SET], the system returns to the items selection sequence.

8.2.14 Rate-Of-Change Limit

The rate-of-change limit is used to eliminate high electrical noise contained in the process flow signal.

To check electrical noise, two parameters are defined: rate-of-change limit (set in percent value of the span) and control limit time (set in units of seconds). Normally the flowmeter produces the analog output signal by sampling the flow rate signal at 1/24 (or 1/12) of a second sampling rate. If the sampled value exceeds the set rate-of-change limit value based on the averaged flow rate value up until the sampled time, the system will reject that sampled value and instead the averaged value including the rate-of-change limit value in place of the rejected sampled value will be output. However, if the limit-exceeding sampled value continues for the same flow direction for more than the preset control limit time, that data will be used as the output signal. The setting ranges for these two parameters are as follows:

- **Rate-of-change limit**

0 to 30 %/sampling rate (in increments of 0.5 %)

Where the sampling rate is either 1/24, 1/12 or 1/6 of a second depending on the excitation frequency as shown below:

Excitation frequency	Sampling rate
24 Hz	1/24 sec
12 Hz or 6 Hz	1/12 sec

- **Control limit time:** 0 to 20 sec (in increments of 1 second)

NOTE

If "0" is set in either of these parameters, the rate-of-change limit function is disabled. Proceed as follows to check or change the rate-of-change limit value and the control limit time.

- To check the rate-of-change limit value and the control limit time:

Key operation	Display example	Description
SET <input type="checkbox"/>	K1: LIMIT RATE 05.0 %	Press [SET] first to start the items selection sequence and select K1: LIMIT RATE from among the configuration items using [▶] and [▲] keys. Then press [SET] again to display the current rate-of-change limit time.
SET <input type="checkbox"/>	K1: LIMIT RATE	Pressing [SET], the system returns to the items selection sequence.

Rate-of-change limit value and control limit time can be selected by the configuration items as follows:

Rate-of-change limit value	K1: H. LIMIT RATE
Control limit time	K2: H. LIMIT TIME

■ To change the rate-of-change limit value:

The following example shows how to change the rate-of-change limit value from 10.0 % to 15.0 %.

Key operation	Display example	Description
SET <input type="checkbox"/>	K1: LIMIT RATE 10.0 %	Press [SET] first to start the items selection sequence and select K1: LIMIT RATE from among the configuration items using [▶] and [▲] keys. Then press [SET] again to display the current rate-of-change limit value (10.0 % in this example).
▶ <input type="checkbox"/>	K1: LIMIT RATE <u>1</u> 0.0 %	Pressing [▶], the cursor appears. Then press [▶] as many times as necessary to move the cursor to the digit to be changed.
▲ <input type="checkbox"/>	K1: LIMIT RATE 1 <u>5</u> .0 %	Change the value to "5" by pressing [▲] five times. (Note) (If necessary, move the cursor to the next digit to be changed by pressing [▶], and change the value.).
SET <input type="checkbox"/>	K1: LIMIT RATE 15.0 %	Pressing [SET], the cursor disappears and changed rate-of-change limit value display flickers. Press [SET] again to save the value.
SET <input type="checkbox"/>	<u>K</u> 1: LIMIT RATE	Pressing [SET], the system returns to the items selection sequence.

Note: If you try to set the value outside the valid range, an error message * H. OVER SPEC appears. Set the value within the specified range.

To change the control limit time, select the item **K2: LIMIT TIME**.

8.2.15 Fixed-Value Output

The fixed-value output is used to output a fixed current and a fixed pulse output independent of the flow rate signal. (The fixed pulse output is available only when DO1 is used for PULSE OUT function.) The fixed-value output can be set in the ranges described below. (Current output and pulse output can be set and output at the same time.)

- **Fixed current output:** 3 to 24 mA (in increments of 0.1 mA)
- **Fixed pulse output:** 0 to 1000 pps (in increments of 1 pps)

If you have disabled this function (set to OFF), you do not have to set the subsequent current and pulse output values.

When this function is enabled (set to ON), the measured data is displayed with the primary indicating unit only on the first line of the display and the fixed current output is displayed on the second line of the display. Other data output and display conditions are as follows:

- **Current output:** User-set current output
- **Pulse output:** Pulse output with a user-set counting rate
- **Digital output(s):** Previous status is retained (excluding pulse output).
- **Data Display:** Instantaneous flow rates and flow velocity (no totalization)

Display example:

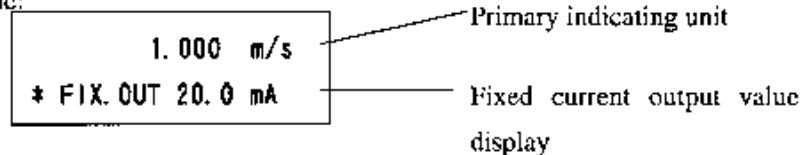

This fixed-value output function does not work in the calibration mode.

Proceed as follows to check or change the enable/disable status of the fixed-value output and its output values.

- To check the enable/disable status of the fixed-value output and its output values:

Key operation	Display example	Description
SET <input type="checkbox"/>	L1: FIXED OUT ON	Press [SET] first to start the items selection sequence and select L1: FIXED OUT from among the configuration items using [▶] and [▲] keys. Then press [SET] again to display the fixed-value output enable/disable status.
SET <input type="checkbox"/>	<u>L</u> 1: FIXED OUT	Pressing [SET], the system returns to the items selection sequence.

Fixed-value output enable/disable status, fixed current output and fixed pulse output can be selected by the configuration items as follows:

Fixed-value enable/disable status	L1: FIXED OUT
Fixed current output	L2: FIX. CURR.
Fixed pulse output	L3: FIX. PULSE

■ To change the enable/disable status of the fixed-value output and its output values:

The following example shows how to enable the fixed-value output function and to set its fixed current output to 20 mA DC.

Key operation	Display example	Description
SET <input type="checkbox"/>	L1: FIXED OUT OFF	Press [SET] first to start the items selection sequence and select L1: FIXED OUT from among the configuration items using [▶] and [▲] keys. Then press [SET] again to display the current fixed-output enable/disable status (OFF in this example).
▶ <input type="checkbox"/>	L1: FIXED OUT OFF	Pressing [▶], the cursor appears
▲ <input type="checkbox"/>	L1: FIXED OUT ON	Select "ON" by pressing [▲].
SET <input type="checkbox"/>	L2: FIX. CURR. 10.0 mA	Pressing [SET], the selected status (ON) flickers. Press [SET] again to save the status. Then the system goes to the fixed current value setting sequence.
▶ <input type="checkbox"/>	L2: FIX. CURR. 10.0 mA	Move the cursor to the digit to be changed.
▲ <input type="checkbox"/>	L2: FIX. CURR. 20.0 mA	Change the value to "2" by pressing [▲] twice. (If necessary, move the cursor to another digit by pressing [▶] and change the value.) (Note 1)
SET <input type="checkbox"/>	L3: FIX. PULSE 100 PPS	Pressing [SET], the cursor disappears and the changed value display flickers. Press [SET] again to save the value. Then the system goes to the fixed pulse output setting sequence. (Note 2)
SET <input type="checkbox"/>	L3: FIX. PULSE 100 PPS	Pressing [SET], the cursor disappears and the fixed pulse output value flickers. Press [SET] again to save the value.
SET <input type="checkbox"/>	L3: FIX. PULSE	Pressing [SET], the system returns to the items selection sequence.

Notes:

1. If you try to set the fixed-value output above the allowable range, an error message * H. OVER SPEC appears. Try to set the value within the specified range.
2. If PULSE OUT is not selected for digital output, the subsequent pulse output setting sequence will not be displayed.

■ To change the fixed pulse output value:

The following example shows how to change the fixed pulse output value from 50 pps to 100 pps.

Key operation	Display example	Description
SET <input type="checkbox"/>	L3: FIX. PULSE 050 PPS	Press [SET] first to start the items selection sequence and select L3: FIX. PULSE from among the configuration items using [▶] and [▲] keys. Then press [SET] again to display the current fixed pulse output value (50 pps in this example).
▶ <input type="checkbox"/>	L3: FIX. PULSE <u>0</u> 50 PPS	Pressing [▶], the cursor appears. (if necessary, move the cursor by pressing [▶] to the digit to be changed.)
▲ <input type="checkbox"/>	L3: FIX. PULSE 150 PPS <u>1</u> 00 PPS	Change the value to "1" by pressing [▲]. Then move the cursor to another digit to change and change the value. In this example repeat this process until the display shows "100 pps."
SET <input type="checkbox"/>	L3: FIX. PULSE <u>1</u> 00 PPS	Pressing [SET], the cursor disappears and the changed value display flickers. Press [SET] again to save the value.
SET <input type="checkbox"/>	L3: FIX. PULSE	Pressing [SET], the system returns to the items selection sequence.

Fixed current output value can be changed by selecting the configuration item L2: FIX. CURR.

8.2.16 Zero Offset Adjustment

Zero offset can be applied to make the flowmeter outputs comparable to process values measured by other instruments. If the zero adjustment described in 6.2 requiring a zero flow rate condition can be performed, this zero offset adjustment is not needed. When the zero adjustment is completed, zero offset will be automatically cleared to zero.

Zero offset can be set in the range described below:

Zero offset: ± 0.125 m/s (± 1.25 % of 10 m/s—maximum range) maximum

Proceed as follows to check or change the zero offset value.

■ To check the zero offset value:

Key operation	Display example	Description
SET <input type="checkbox"/>	M1: MANUAL ZERO +002.5 %	Press [SET] first to start the items selection sequence and select M1: MANUAL ZERO from among the configuration items using [▶] and [▲] keys. Then press [SET] again to display the current zero offset value
SET <input type="checkbox"/>	M1: MANUAL ZERO	Pressing [SET], the system returns to the items selection sequence.

■ To change the zero offset value:

Calculate the zero offset value with the following equation:

$$\text{Zero offset value (\%)} = \{(\text{actual flow rate}) - (\text{LF404 measured value})\}$$

The zero offset value should be calculated in percent value for Range 1. See the following example.

(Example)

Measured condition	Flow rate	% in measuring span
Actual flow rate obtained from other instrument.	10.0 m ³ /min	50 %
LF404 measured value	10.5 m ³ /min	52.5 %
Zero offset	_____	-2.5 %

If zero offset is set to -2.5 %, the LF404 converter will output 50.0 % flow rate instead of 52.5%.

The following example shows how to change the zero offset value from +1.0% to -2.5%.

Key operation	Display example	Description
SET <input type="checkbox"/>	M1: MANUAL ZERO +001. 0%	Press [SET] first to start the items selection sequence and select M1: MANUAL ZERO from among the configuration items using [▶] and [▲] keys. Then press [SET] again to display the current zero offset value.
▶ <input type="checkbox"/>	M1: MANUAL ZERO +001. 0%	Pressing [▶], the cursor appears. (If necessary, press [▶] as many times as necessary to move the cursor to the desired digit to change.)
▲ <input type="checkbox"/>	M1: MANUAL ZERO -001. 0% -002. 0% -002. 5%	Change the sign code (“+” to “-”) by pressing [▲]. Then move the cursor to another digit by pressing [▶] and change the value. In this example repeat this process until the display shows “-002.5%.” (Note)
SET <input type="checkbox"/>	M1: MANUAL ZERO -002. 5%	Pressing [SET], the cursor disappears and the changed value display flickers. Press [SET] again to save the value.
SET <input type="checkbox"/>	M1: MANUAL ZERO	Pressing [SET], the system returns to the setting items selection sequence.

Note: If you try to set the value above +0.125 m/s or below -0.125 m/s, the error messages

* H. OVER SPEC or * L. OVER SPEC, respectively, appears.

Set the value within ± 0.125 m/s.

***Note**

Only in case of the converter for special specification (refer to 7.3.3 “Converter for Special specifications”), read from 8.2.17 to 8.2.20,

The normal converter does not have these parameters, and these parameters do not appear in the items selection sequence.

8.2.17 Password

The converter for special specifications have password that protects from calibrating and changing part of parameter that influences measurement.

Proceed as follows to check or change the password.

■ To check the password:







Key operation	Display example	Description
SET <input type="checkbox"/>	A4: PASSWORD 123	Press [SET] first to start the items selection sequence and select A4: PASSWORD from among the configuration items using [▶] and [▲] keys Then press [SET] again to display the current password(123).
SET <input type="checkbox"/>	A4: PASSWORD	Pressing [SET], the system returns to the items selection sequence.

Note: In case of inputting wrong password in the password input mode

Key operation	Display example	Description
SET <input type="checkbox"/>	A4: PASSWORD ***	Press [SET] first to start the items selection sequence and select A4: PASSWORD from among the configuration items using [▶] and [▲] keys Then press [SET] again to display the “***”.
SET <input type="checkbox"/>	A4: PASSWORD	Pressing [SET], the system returns to the items selection sequence.

■ To change the password:

The following example shows how to change the password from 123 mm to 453 mm.

Key operation	Display example	Description
SET 	A4: PASSWORD 123	Press [SET] first to start the items selection sequence and select A4: PASSWORD from among the configuration items using [▶] and [▲] keys. Press [SET] again to display the current password (123 in this example). Case of inputting wrong password in the password input mode, the current password doesn't appear, but "****" appears.
	A4: PASSWORD <u>1</u> 23	Pressing [▶], the cursor appears. Then press [▶] as many times as necessary to move the cursor to digit to be changed.
 	A4: PASSWORD <u>4</u> 23 4 <u>5</u> 3	Change the value by pressing [▲]. Then move the cursor to another digit by pressing [▶] and change the value. In this example repeat this process until the display shows "453" (Note)
SET 	A4: PASSWORD 456	Pressing [SET], the cursor disappears and the changed display flickers. Press [SET] again to save the value.
SET 	A4: PASSWORD	Pressing [SET], the system returns to the items selection sequence.

Note:

1. Setting "000" to the password, password input mode doesn't appear and all configuration parameter and calibrate can be changed.
2. If password is set, do not forget the password. In case of forgetting password, refer to next page, readout the password. But the administration, including the way to readout password,

<Notice>

The method of PASSWORD MANAGEMENT including its lifting or reading out requires to be controlled by our system's own risk.

*In case of forgetting password (reading out password)









Proceed as follows to only readout password in case of forgetting password. In the other case, do not do it.

<Notice>

The method of PASSWORD MANAGEMENT including its lifting or reading out requires to be controlled by system's own risk.

■ **Readout the password:**

The following example shows how to readout the password .

Key operation	Display example	Description
		Before turning on power, open the housing cover for LCD display, and short-circuit between TT-RST and TT-G that is back of the operation panel with the clip-type cable.(refer to Figure 8.1) After that, turning on power, LCD back-light bright in the operation panel
	10.00 m/s 100.0 %	Open the clip-type cable. LCD displays "SIGNAL CHECK", and after that displays measured data.(measurement mode)
SET 	PASSWORD INPUT 000	Pressing [SET], password input mode and the cursor appears.
 	PASSWORD INPUT 100 120 123	Change the value by pressing [▲],and [▶].
SET 	PASSWORD INPUT 123	Pressing [SET], the cursor disappears and the changed display flickers. Press [SET] again to input the value.
SET 	A1: EX. CURR.	Whether input password agrees or dose not agree , the items selection sequence, "A1: EX. CURR" appears.
 	A4: PASSWORD	Select A4: PASSWORD from among the configuration items using [▶] and [▲] keys .
SET 	A4: PASSWORD 123	Press [SET] again to display the current password(123).

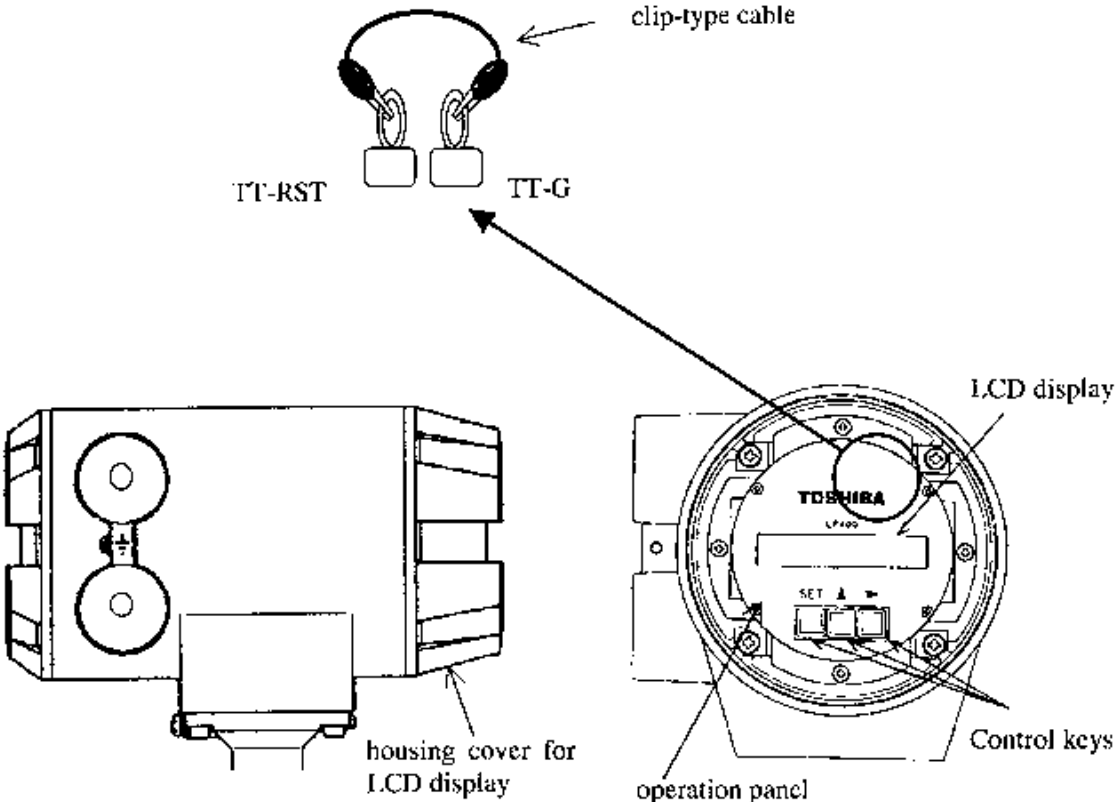

Figure 8.1

8.2.18 4-20mA Alarm Output

The 4-20mA Alarm output is the value of current output at converter alarms as empty pipe alarm or self-diagnostics alarms.

You can select the various current output value at converter alarms shown below.

■ 4-20mA Alarm output Functions

4-20 ALM. Out items	Current Output Value at Converter Alarms
0: UNDER 3.0mA	Under 3.0mA output
1: 4.0mA	4.0mA output
2: HOLD	Measured data hold
3: OVER 24.0mA	Over 24.0mA output

Proceed as follows to check or change the burn out.

■ To check the 4-20mA Alarm output functions:

Key operation	Display example	Description
SET <input type="checkbox"/>	D3: 4-20 ALM. OUT 1: 4. 0mA	Press [SET] first to start the items selection sequence and select D3: 4-20 ALM.OUT from among the configuration items using [▶] and [▲] keys. Then press [SET] again to display the 4-20 ALM.OUT function.
SET <input type="checkbox"/>	<u>D3</u> : 4-20 ALM. OUT	Pressing [SET], the system returns to the items selection sequence.

■ To change the 4-20mA Alarm output functions:

The following example shows how to change the 4-20mA Alarm output function from No. 1 to No. 3.

Key operation	Display example	Description
SET <input type="checkbox"/>	D3: 4-20 ALM. OUT 1: 4.0mA	Press [SET] first to start the items selection sequence and select D3 4-20 ALM.OUT from among the configuration items using [▶] and [▲] keys. Then press [SET] again to display the current burn out function (1: 4.0mA in this example).
▶ <input type="checkbox"/>	D3: 4-20 ALM. OUT 1: 4.0mA	Pressing [▶], the cursor appears.
▲ <input type="checkbox"/>	D3: 4-20 ALM. OUT 3: 24.0mA	Change the value to "3" by pressing [▲] twice.
SET <input type="checkbox"/>	D3: 4-20 ALM. OUT 3: 24.0mA	Pressing [SET], the cursor disappears and the new burn out function display flickers. Press [SET] again to save the new function.
SET <input type="checkbox"/>	D3: 4-20 ALM. OUT	Pressing [SET], the system returns to the items selection sequence.

8.2.19 DI detective Level

In case of counter (pulse output) control is selected as DI, you can set detective level ,H level or L level.

■ **DI detective Level (only case counter control is selected as DI):**

DI DET. LEVEL Items	Digital input function	Counter control signal
0: L LEVEL	DI 1:C STA/STP (Totalizer Start/Stop)	H level signal input: COUNTER STOP L level signal input: COUNTER START
	DI 2:C RES/STA (Totalizer Reset/Start)	H level signal input: COUNTER START L level signal input: COUNTER RESET
1: H LEVEL	DI 1:C STA/STP (Totalizer Start/Stop)	H level signal input: COUNTER START L level signal input: COUNTER STOP
	DI 2:C RES/STA (Totalizer Reset/Start)	H level signal input: COUNTER RESET L level signal input: COUNTER START

The detective level of DI can be selected from H level and L level for Counter control which are the totalizer Start/Stop the totalizer Reset/Start. If the function except these counter control is selected as DI function, the detective level is ignored.



Proceed as follows to check or change the DI detective level.

■ **To check the DI detective level:**

Key operation	Display example	Description
SET <input type="checkbox"/>	F6:DI DET. LEVEL 1:H LEVEL	Press [SET] first to start the items selection sequence and select F6: DI DET. LEVEL from among the configuration items using [▶] and [▲] keys. Then press [SET] again to display the DI detective level.
SET <input type="checkbox"/>	F6:DI DET. LEVEL	Pressing [SET], the system returns to the items selection sequence.

■ To change the DI detective level:

The following example shows how to change the DI detective level from H level to L level.

Key operation	Display example	Description
SET <input type="checkbox"/>	F6:DI DET. LEVEL 1:H LEVEL	Press [SET] first to start the items selection sequence and select F6: DI DET. LEVEL from among the configuration items using [▶] and [▲] keys. Then press [SET] again to display the current preset level function (1: H LEVEL in this example).
	F6:DI DET. LEVEL 1:H LEVEL	Pressing [▶], the cursor appears.
	F6:DI DET. LEVEL 0:L LEVEL	Change the value to "0:L LEVEL" by pressing [▲].
SET <input type="checkbox"/>	F6:DI DET. LEVEL 0:L LEVEL	Pressing [SET], the cursor disappears and the new preset level function display flickers. Press [SET] again to save the new function.
SET <input type="checkbox"/>	F6:DI DET. LEVEL	Pressing [SET], the system returns to the items selection sequence.

8.2.20 Preset Function

The various preset point output functions shown below can be selected.

■ Preset Point Output Functions

DI function	Preset point output level function
0: HOLD	Output status level hold
1: 50ms PULSE	Pulse out (pulse width 50ms)
2: 500ms PULSE	Pulse out (pulse width 500ms)



Proceed as follows to check or change the preset point output functions.

■ To check the preset functions:

Key operation	Display example	Description
SET <input type="checkbox"/>	H2: PRESET FUNCT 0: HOLD	Press [SET] first to start the items selection sequence and select H2: PRESET FUNCT from among the configuration items using [▶] and [▲] keys. Then press [SET] again to display the current preset level function.
SET <input type="checkbox"/>	H2 PRESET FUNCT	Pressing [SET], the system returns to the items selection sequence.

■ To change the preset functions:

The following example shows how to change the preset level function from No. 0 to No. 1.

Key operation	Display example	Description
SET <input type="checkbox"/>	H2: PRESET FUNCT 0:HOLD	Press [SET] first to start the items selection sequence and select H2: PRESET FUNCT from among the configuration items using [▶] and [▲] keys. Then press [SET] again to display the current preset level function (0: HOLD in this example).
 <input type="checkbox"/>	H2: PRESET FUNCT 0:HOLD	Pressing [▶], the cursor appears.
 <input type="checkbox"/>	H2: PRESET FUNCT 1:50ms PULSE	Change the value to "1" by pressing [▲].
SET <input type="checkbox"/>	H2: PRESET FUNCT 1:50ms PULSE	Pressing [SET], the cursor disappears and the new preset level function display flickers. Press [SET] again to save the new function.
SET <input type="checkbox"/>	H2: PRESET FUNCT	Pressing [SET], the system returns to the items selection sequence.

9. Calibration

9.1 Calibration Items

You can conduct the following in the calibration mode:

- Checks or calibrates the zero and span of the LF404 converter by using a simulation signal.
- Checks of the excitation current.

To change the mode to the calibration mode, see 7.3.1 , "Mode Change."

IMPORTANT

To check or change the zero and span of the converter, follow the procedure described below. However, these are already checked and calibrated when shipped from the factory. Do not change these settings unless it is necessary to calibrate in the field.

Calibration items are listed below. See each section for detailed procedure.

Section	Configuration item	Display example		Page
9.2.1	0 % flow rate calibration	N1:FLOW CAL 0%	0.0 %	104
9.2.2	50 % flow rate calibration	N2:FLOW SIG.50%	50.0 %	105
9.2.3	100 % flow rate calibration	N3:FLOW CAL100%	100.0 %	106
9.2.4	Excitation current	N4:EX. CURR.DSP.	0.2100 A	107

9.2 Calibration Using Converter Signal Source

9.2.1 0 % Flow Rate Calibration

- To check the zero point of flow measurement:

Key operation	Display example	Description
SET <input type="checkbox"/>	N1:FLOW CAL 0% 0.0%	Press [SET] first to start the items selection sequence and select N1: FLOW CAL 0% from among the configuration items using [▶] and [▲] keys. Then press [SET] again to go into the calibration mode and calculate and display zero point using a simulation signal.
SET <input type="checkbox"/>	N1:FLOW CAL 0%	Pressing [SET], the system returns to the items selection sequence.

- To change the zero and span of the converter:

Key operation	Display example	Description
SET <input type="checkbox"/>	N1:FLOW CAL 0% 0.1%	Press [SET] first to start the items selection sequence and select N1: FLOW CAL 0% from among the setting items using [▶] and [▲] keys. Then press [SET] again to go into the calibration mode and calculate and display zero point using a simulation signal.
▶ <input type="checkbox"/>	ADJUST READY 0.1%	Pressing [▶], "ADJUST READY" appears as shown left and the system goes into a calibration ready condition. (Note 1)
———	N1:FLOW CAL 0% * CAL. 0% ADJ.	Pressing [SET], "** CAL. 0% ADJ." appears as shown left and the system starts the zero calibration. The zero calibration takes about 3 to 6 seconds. (Note 2)
SET <input type="checkbox"/>	N1:FLOW CAL 0% 0.0%	Newly calibrated zero point appears.
SET <input type="checkbox"/>	N1:FLOW CAL 0%	Pressing [SET], the system returns to the items selection sequence.

Notes:

- 1.To cancel zero calibration, press [▲]. The system returns to the point where the zero point display appears.
- 2.Calibration time depends on the excitation frequency (24 Hz: 3 sec, 12 Hz and 6 Hz: 6 sec).

9.2.2 50 % Flow Rate Calibration

Using the converter's internal calibration circuit, the system can calibrate the 50% flow rate point. The 50% flow rate point calibration must be executed after conducting the 100% flow rate (span) calibration. The 50% flow rate calibration may differ depending on the 100% flow rate calibration result.

■ To check the 50% flow rate point of flow measurement:

Key operation	Display example	Description
SET <input type="checkbox"/>	N2: FLOW SIG 50% 50.1 %	Press [SET] first to start the items selection sequence and select N2: FLOW SIG 50% from among the configuration items using [▶] and [▲] keys. Then press [SET] again to go into the calibration mode and calculate and display 50% flow rate point using a simulation signal.
SET <input type="checkbox"/>	N2: FLOW SIG 50%	Pressing [SET], the system returns to the items selection sequence.

■ To change the 50% flow rate point of the converter:

Key operation	Display example	Description
SET <input type="checkbox"/>	N2: FLOW SIG 50% 50.1 %	Press [SET] first to start the items selection sequence and select N2: FLOW SIG 50% from among the configuration items using [▶] and [▲] keys. Then press [SET] again to go into the calibration mode and calculate and display 50% flow rate point using a simulation signal.
▶ <input type="checkbox"/>	ADJUST READY 50.1 %	Pressing [▶], "ADJUST READY" appears as shown left and the system goes into a calibration ready condition. (Note 1)
—	N2: FLOW SIG 50% ≠ CAL. 50% ADJ.	Pressing [SET], "* CAL. 50% ADJ." appears as shown left and the system starts the 50% calibration. The zero calibration takes about 3 to 6 seconds. (Note 2)
SET <input type="checkbox"/>	N2: FLOW SIG 50% 50.0 %	Newly calibrated 50% flow rate point appears.
SET <input type="checkbox"/>	N2: FLOW SIG 50%	Pressing [SET], the system returns to the items selection sequence.

Notes:

- To cancel 50% flow rate calibration, press [▲]. The system returns to the point where 50% flow rate is displayed.
- Calibration time depends on the excitation frequency (24 Hz: 3 sec, 12 Hz and 6Hz: 6 sec).

9.2.3 100 % Flow Rate (Span) Calibration

Using the converter's internal calibration circuit, the system can calibrate the 100% flow rate point (hereafter called span).

■ To check the span of the converter:

Key operation	Display example	Description
SET <input type="checkbox"/>	N3:FLOW CAL100% 100.1 %	Press [SET] first to start the items selection sequence and select N3: FLOW CAL100% from among the configuration items using [▶] and [▲] keys. Then press [SET] again to go into the calibration mode and calculate and display the span using a simulation signal.
SET <input type="checkbox"/>	N3:FLOW CAL100%	Pressing [SET], the system returns to the items selection sequence.

■ To change the span of the converter:

Key operation	Display example	Description
SET <input type="checkbox"/>	N3:FLOW CAL100% 100.1 %	Press [SET] first to start the items selection sequence and select N3: FLOW CAL100% from among the configuration items using [▶] and [▲] keys. Then press [SET] again to go into the calibration mode and calculate and display 100% flow rate point using a simulation signal.
▶ <input type="checkbox"/>	ADJUST READY 100.1 %	Pressing [▶], "ADJUST READY" appears as shown left and the system goes into a calibration ready condition. (Note 1)
—	N3:FLOW CAL100% * CAL. 100% ADJ.	Pressing [SET], "** CAL. 100% ADJ.," appears as shown left and the system starts the 100% calibration. The zero calibration takes about 3 to 6 seconds. (Note 2)
SET <input type="checkbox"/>	N3:FLOW CAL100% 100.0 %	Newly calibrated 100% flow rate point appears.
SET <input type="checkbox"/>	N3:FLOW CAL100%	Pressing [SET], the system returns to the items selection sequence.

Notes:

- To cancel the span calibration, press [▲]. The system returns to the point where 100% flow rate is displayed.
- Calibration time depends on the excitation frequency (24 Hz: 3 sec, 12 Hz and 6Hz: 6 sec).

9.2.4 Checking the Excitation Current Value

You can monitor the exciting current value. The excitation current value is factory adjusted when shipped. Contact your nearest Toshiba representative if any change is necessary.

■ To check the exciting current value:

Key operation	Display example	Description
SET <input type="checkbox"/>	N4: EX. CURR. DSP. 0.2100 mA	Press [SET] first to start the items selection sequence and select N4: EX. CURR. DSP. from among the configuration items using [▶] and [▲] keys. Then press [SET] again to display the excitation current value.
SET <input type="checkbox"/>	N4: EX. CURR. DSP.	Pressing [SET], the system returns to the items selection sequence.

10. Digital I/O Functions

The LF404 converter has one standard digital output (DO1) terminal. This terminal can be used in various ways, such as a pulse output, or an alarm output terminal. One more digital output (DO2) and one digital input (DI) are optionally available.

Digital I/O functions described below can be assigned for DO1, DO2 and DI.

Functions	Description
Totalization	<ul style="list-style-type: none"> ■ The converter totalizes volumetric flow values. ■ The totalized flow can be output as a pulse signal (DO1 only) scaled by a user-specified factor (counting rate). ■ The totalizer and pulse signal (DO1 only) can be controlled (starts, stops and resets) with an external signal (DI).
Multiple Ranges	<ul style="list-style-type: none"> ■ Multiple measuring ranges can be switched according to the process flow rates either automatically or by an external signal (DI).
Forward and Reverse flow measurements	<ul style="list-style-type: none"> ■ Forward and reverse flows can be measured. The forward and reverse flow measurements can be used together with multiple range switching function.
High and Low Limit Alarms	<ul style="list-style-type: none"> ■ Outputs an alarm signal (DO1 or DO2) when the process signal exceeds or stays below the limit values.
Empty Pipe Alarm	<ul style="list-style-type: none"> ■ The detector pipe must be filled with fluid all the time. When it is not filled with fluid, the converter outputs an alarm signal (DO1 or DO2).
Totalizer Preset Point	<ul style="list-style-type: none"> ■ When the totalized flow reaches its preset count value, the converter outputs a contact output signal (DO1 or DO2).
Remote Zero Adjustment	<ul style="list-style-type: none"> ■ Zero adjustment (on-stream at zero flow rate) can be started by an external signal (DI).
Fixed-value Output	<p>Fixed current output and fixed pulse output can be used to check a process loop circuit. An external signal (DI) can also be used to control this fixed-value output.</p>
Converter Failure Alarm	<ul style="list-style-type: none"> ■ The converter outputs an alarm signal (DO1 or DO2) if an error such as memory error or excitation circuit error occurs.

10.1 Digital I/O Specifications

Digital I/O specifications for the LF404 converter are described below:

- **Digital Output 1(DO1,) (standard)**
 Output type: Transistor open collector
 Number of outputs: 1
 Capacity: 30 V dc, 200 mA maximum
- **Digital Output 2(DO2) (option),**
 Output type: Solidstate relay (non polarity)
 Number of outputs: 1
 Capacity: 50 V dc, 150 mA maximum
- **Digital Input (DI) (option),**
 Input signal: 20 to 30 V dc voltage signal
 - High input level—20 to 30 V dc
 - Low input level—2 V dc maximum
 Input resistance: Approximately 2.7 kΩ
 Number of inputs: One point

- Each I/O terminal can be used as a specified function terminal when selected.
- Terminal COM is the signal COMMON for the other three terminals (DO1, DO2 and DI).
- Each terminal is isolated from the internal circuits.
 (The output terminals are not isolated from each other.)

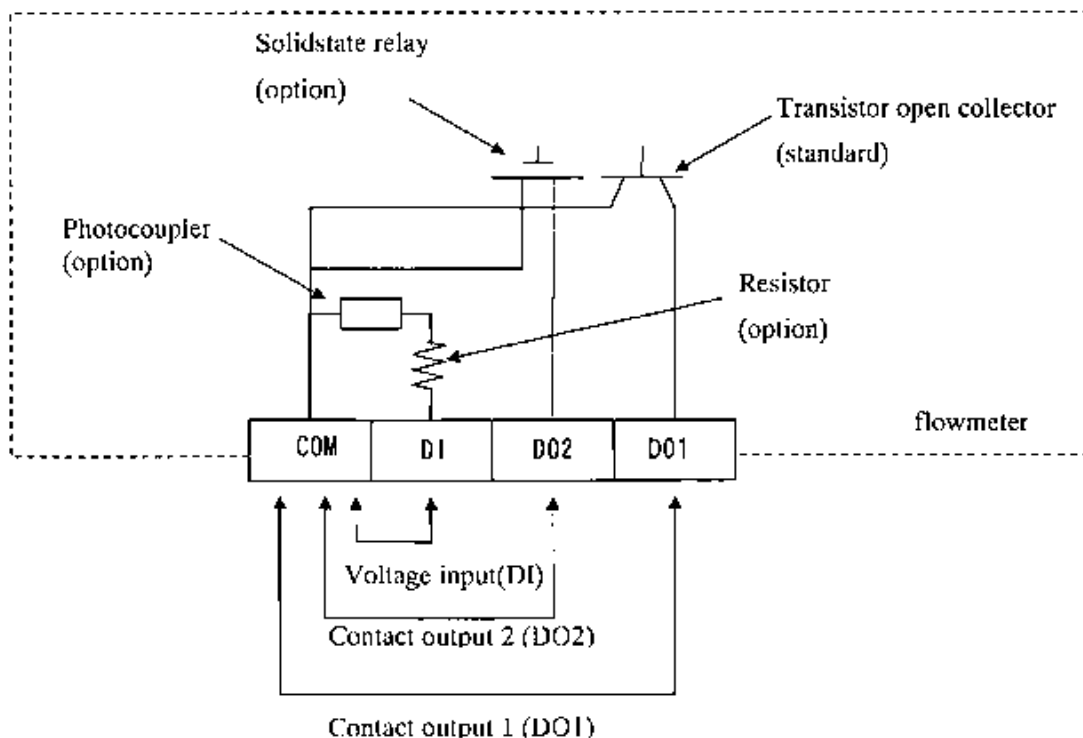

10.2 Totalizer and Pulse Output

To use the totalizer and pulse output for external use, proceed as follows.

Counting Rate and Pulse Width Settings

- Set the counting rate (flow volume per count) and the pulse width. Refer to 8.2.10, "Counting Rate".
 - * The counting rate should be set so that its rate for 100% flow rate output is within the range from 3.6 to 3600000 pulses/h. (Note 4.)
 - * The pulse width can be set from 0.5ms to 500ms. the pulse width should be set to less than half of the pulse rate for 100% flow rate output. (Note 5.)
- Set the pulse width in accordance with response time of receiving instruments. If the pulse output is not used, pulse width setting is not needed.

DO function setting

- Select DO1 as a pulse output contact signal. Refer to 8.2.9, "Digital I/O" This is not needed if the pulse output is not used.

DI function setting (Note 1.)

- Set one of the DI functions. Refer to 8.2.9, "Digital I/O"
If the type of the flowmeter which has no optional digital input, Type Specification Code LF404***1 (Ninth column; "1"), select the DI function according to the way described in the (Note 1.)

Indicating Unit Setting

- Select an indicating unit for UNIT 1 and/or UNIT 2 among units for totalization (m³, l, ml, bbl, gal or COUNT). (Note 2)
- * In case of the converter for special specifications (refer to 7.3.3 "Converter for Special specifications"), select an indicating unit for UNIT 1 and/or UNIT 2 among units for not only totalization (m³, l, ml, bbl, gal or COUNT) but also Code of volumetric.(F, R or B).

Measurement Mode

- Set the operation mode of the system to the measurement mode. Refer to 7.3.1, "Mode Change."

continued on next page

continued from previous page

Clear (reset) the totalizer.

- Clear (reset) the totalizer by pressing [►] key.

If you have changed the counting rate, clear (reset) the totalizer before you start the totalizer

Start the totalizer.

- Start the totalizer by pressing [▲] key and make sure "C" is shown on the display.

(Note 3)

Notes:

1. When the flowmeter has no optional digital input function (ninth column of Type Specification Code: '1'), the movement of the totalizer and pulse output after power on is decided by setting contents of optional digital input (DI) and digital input detective level. Necessary, set the DI function as "0: NO USE".
To let them start, operate the control keys on the panel (Option) according to **Totalizer Operation** in the next subsection.
2. It is preferable to set the indicating unit (UNIT 1 and/or UNIT 2) to one of the units appropriate for totalization just to make sure it is operating correctly.
3. If the indicating unit (UNIT 1 and/or UNIT 2) is not the one for totalization, "C" does not appear on the display.
4. Example for counting rate:

Example

Case Range: 3600m³/h (1m³/s)

Counting rate(pulse rate)

Min.: 3600(m³/h) / 3600000(pulses/h) = 0.001 m³=1 l

Max.: 3600(m³/h) / 3.6(pulses/h) = 1000 m³

5. Example for pulse width:

Example1

Case	Range	:3600m ³ /h (1m ³ /s)
	Counting rate(pulse rate)	:0.001m ³

the pulse rate for 100% flow rate

$$: 3600(\text{m}^3/\text{h}) / 0.001(\text{m}^3) = 3600000\text{pulses/h} = 1000\text{pulses/p}$$

the pulse rate= 1ms

$$* \text{the pulse width(Max.)} = 1\text{ms} / 2 = 0.5\text{ms}$$

Example2

Case	Range	:3600m ³ /h (1m ³ /s)
	Counting rate(pulse rate)	:1000m ³

the pulse rate for 100% flow rate

$$: 3600(\text{m}^3/\text{h}) / 1000(\text{m}^3) = 3.6\text{pulses/h} = 0.001\text{pulses/p}$$

the pulse rate= 1000000ms

$$\text{the pulse width(Max.)} = 1000000\text{ms} / 2 = 500000\text{ms}$$

but, the pulse width is 500ms Max.

$$* \text{the pulse width(Max.)} = 500\text{ms}$$

Example3

Case	Range	:3600m ³ /h (1m ³ /s)
	Counting rate(pulse rate)	:1m ³
	Setting pulse width	:0ms (automatically set)

the pulse rate for 100% flow rate

$$: 3600(\text{m}^3/\text{h}) / 1(\text{m}^3) = 3600\text{pulses/h} = 1\text{pulses/p}$$

the pulse rate= 1000ms

$$\text{the pulse width(Max.)} = 1000\text{ms} / 2 = 500\text{ms}$$



but, the pulse width that automatically set is 100ms Max.

$$* \text{the pulse width (Max.)} = 100\text{ms}$$

Totalizer Operation

■ Using control keys on the panel (option)

To start, stop or clear (reset) the totalizer, follow the procedure described below:

Key operation	Display example	Description
	F 1 C 1. 2300 m/s	Starts the totalizer (and pulse output). "C" for counting will be displayed and either "F" for forward or "R" for reverse flow direction will also be displayed.
	F 123 1. 23000 m/s	Stops the totalizer (and pulse output). "C" shown on the display disappears.
	F 0 1. 23000 m/s	Clears (resets) the totalizer (and pulse output)

NOTES

1. In case of the normal converter or, the converter for special specifications (refer to 7.3.3 "Converter for Special specifications" and setting Code of volumetric, B the indicating unit (UNIT 1 and/or UNIT 2),
 - (1) Setting a bi-directional (forward and reverse) multi-range, the display shows either forward or reverse flow counts depending on the flow direction.
 - (2) Setting a unidirectional multi-range or single-range, the display shows only forward flow counts depending on the flow direction.
2. In case of the converter for special specifications (refer to 7.3.3 "Converter for Special specifications"), setting an indicating unit for UNIT 1 and/or UNIT 2 among units for totalization (m³, l, ml, bbl, gal or COUNT), and setting Code of volumetric. (F or R) the indicating unit (UNIT 1 and/or UNIT 2),
 - (1) Setting code of volumetric F, the display shows forward flow counts.
 - (2) Setting code of volumetric R, the display shows reverse flow counts.
3. When [►] is pressed, the flow counts for both directions will be cleared to zero.
4. Non-volatile memory is used to store the totalizer counter value. Therefore, the value will be retained in the memory even if the power is cut off.

■ Using the optional DI signal

Remote operations for the totalizer and pulse output can be conducted using the optional DI signal. The following functions in the table can be performed. See 8.2.9 "Digital I/O" to select these functions.

DI signal(normal converter, detective level: H level)

Digital input (DI) Functions	DI voltage level	Totalizer and pulse output
Totalizer Start/Stop	L level	Stops the totalizer and the pulse output.
	H level	Starts the totalizer and the pulse output.
Totalizer Reset/Start	H level	Stops and clears (resets) the totalizer.
	L level	Starts the totalizer and the pulse output.

* In case of the converter for special specifications (refer to 7.3.3 "Converter for Special specifications"), you can select Digital Input Detective Level (Only for Counter Control). For detail, see 8.2.19 "Digital Input Detective Level"

*Select H level(1:H LEVEL) : refer to upper table," DI signal(normal converter, detective level: H level)".

*Select L level(0:L LEVEL) : refer to under table," DI signal(converter for special specifications detective level: L level)".

DI signal(converter for special specifications, detective level: L level)

Digital input (DI) Functions	DI voltage level	Totalizer and pulse output
Totalizer Start/Stop	L level	Starts the totalizer and the pulse output.
	H level	Stops the totalizer and the pulse output.
Totalizer Reset/Start	H level	Starts the totalizer and the pulse output.
	L level	Stops and clears (resets) the totalizer.

10.3 Multi-range Functions

Multi-range functions can be set under the configuration item "RANGE TYPE." Refer to 8.2.6, "Span (Range)." Four types of multi-range configurations are available as shown below:

- (1) Automatic selection of unidirectional flow multi-range
- (2) Automatic selection of bidirectional flows multi-range
- (3) Remote selection of unidirectional flow multi-range with an external signal
- (4) Remote selection of bidirectional flows multi-range with an external signal

Proceed as follows to use the multi-range functions.

Range setting

- Set as follows referring to 8.2.5, "Span (Range)."
 1. Select "RANGE TYPE."
 2. Set the span for ranges 1 to 4.
 3. Set the hysteresis value.

DO/DI function setting

- Set DO1 and/or DO2 (option) to use them as range outputs. Refer to 8.2.9, "Digital I/O"
- To select ranges with a remote signal, use DI (option) as a remote signal. Refer to 8.2.9, "Digital I/O"

■ Output performance of multi-range functions

(1) Automatic selection of unidirectional flow multi-range

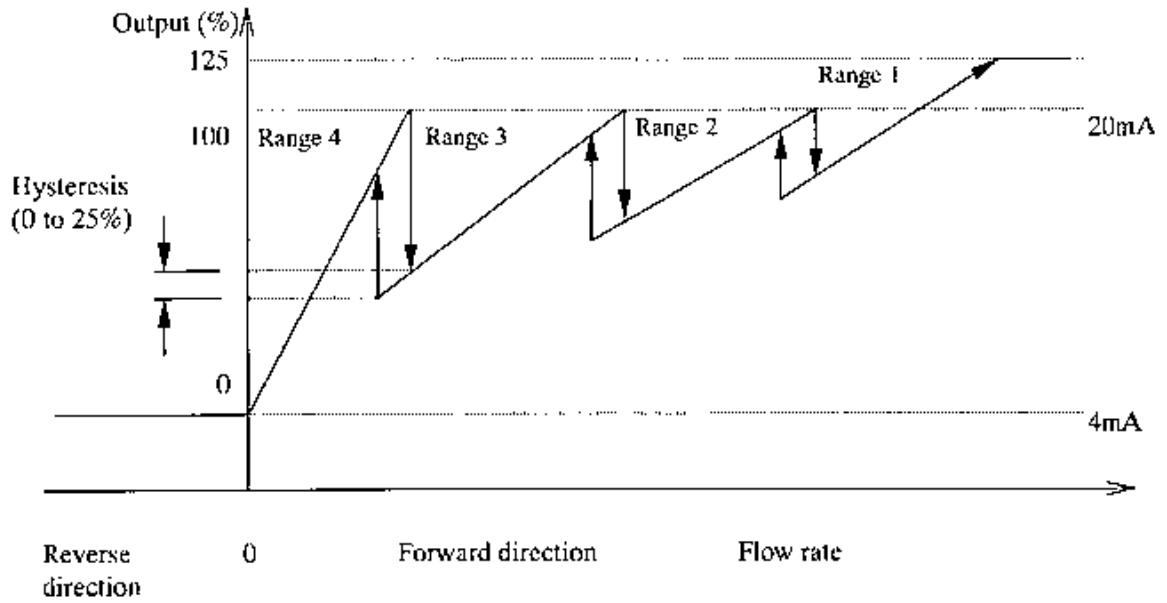

Range output	Output status			
	ON	OFF	ON	OFF
No. 1	ON	OFF	ON	OFF
No. 2	ON	ON	OFF	OFF

Note: The current output for opposite direction flow is 4 mA.

(2) Automatic selection of bidirectional flows multi-range

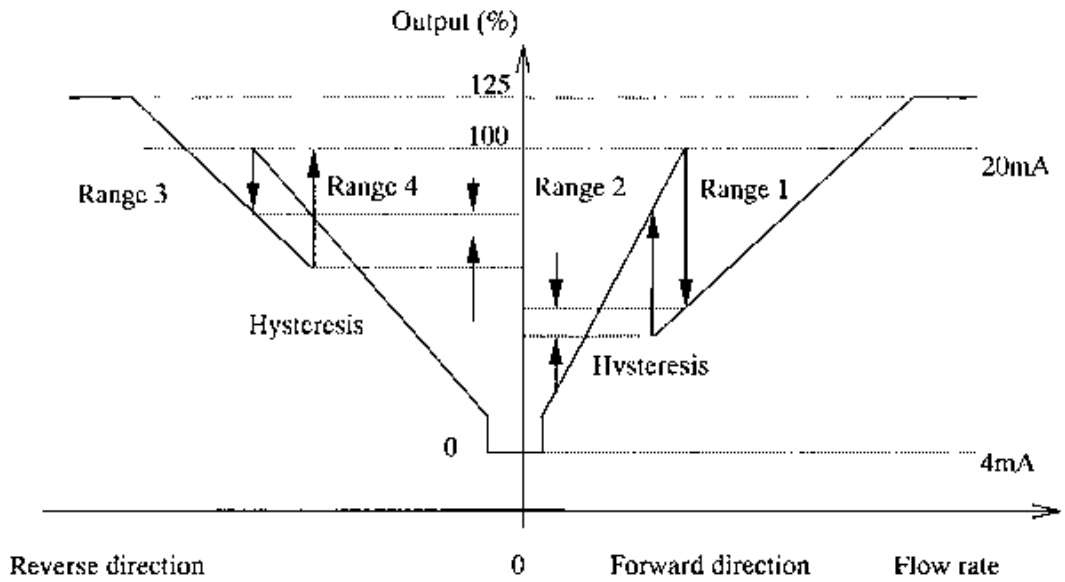

Range output	Output status	
No.1	OFF / ON	ON / OFF
No.2	ON	OFF

■ Reverse to Forward direction change ■ Forward to Reverse direction change

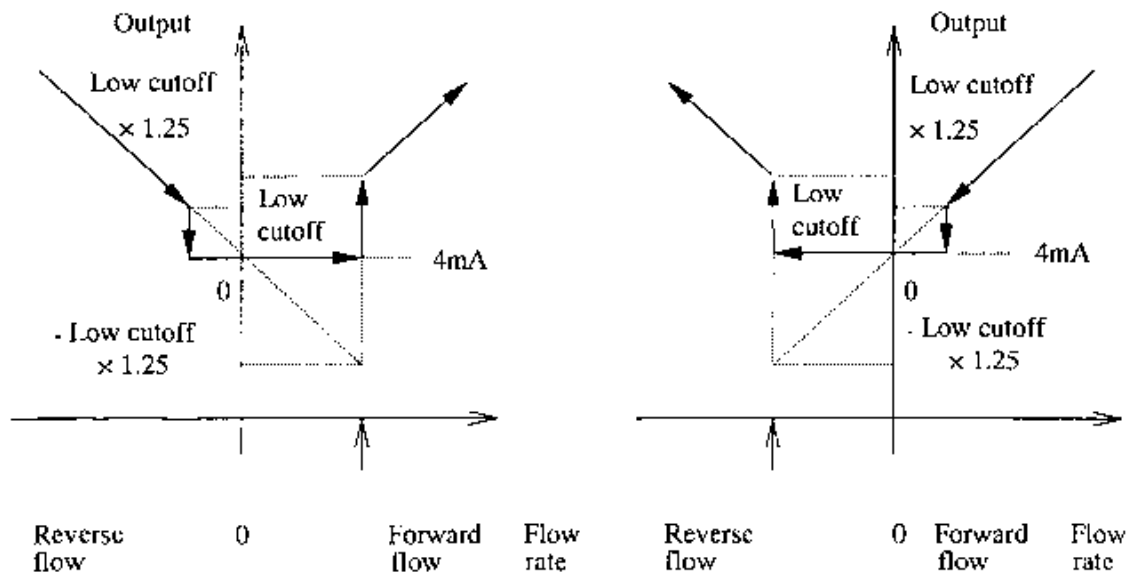

(3) Remote selection of unidirectional flows multi-range with an external signal

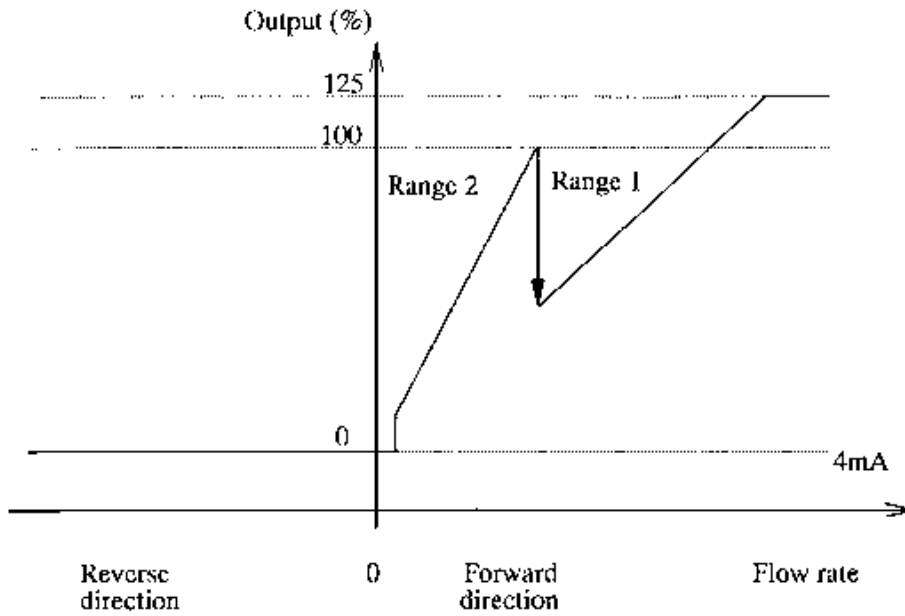

External signal	H level input	I. level input
Range output No. 1	ON	OFF

Note: The current output for opposite direction flow is 4 mA.

(4) Remote selection of bidirectional flows multi-range with an external signal

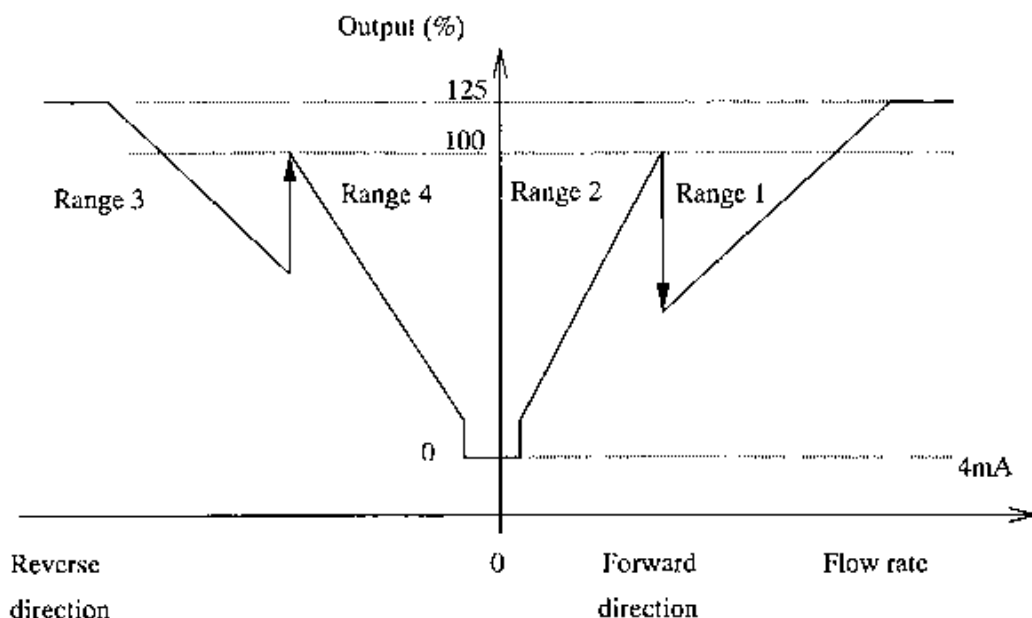

External signal	L level	H level	H level	L level
Range output No.1	OFF	ON	ON	OFF
Range output No.2	ON		OFF	

■ Reverse to Forward direction change ■ Forward to Reverse direction change

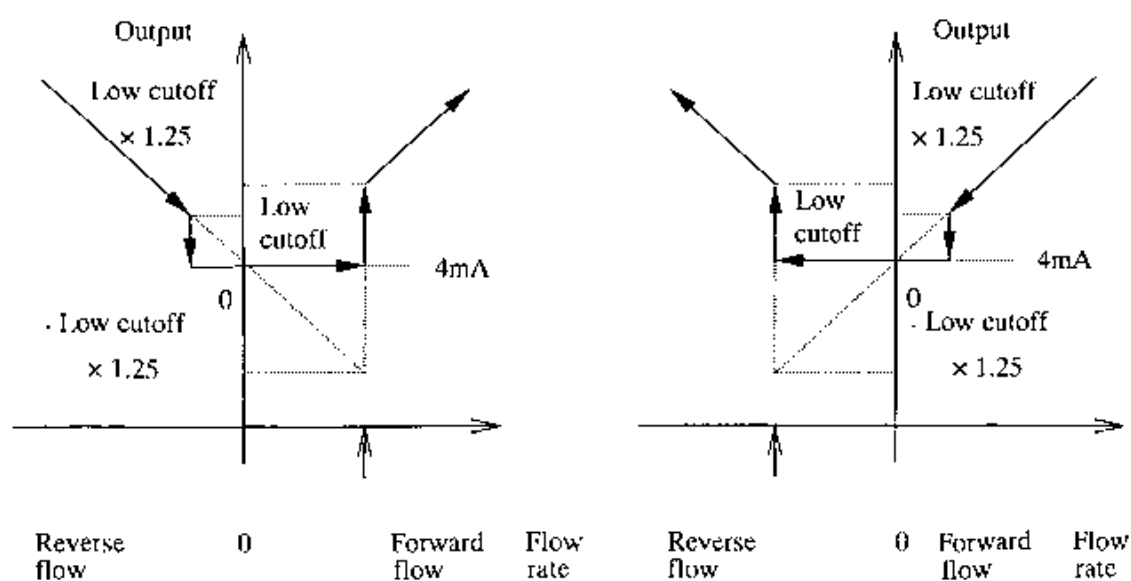

10.4 High and Low Limit Alarms

Proceed as follows to use the high and low limit alarms:

High and Low limit value setting

- Set the high and/or low limit alarm enable/disable status to ON and set the limit value for high and/or low alarm. See 8.2.12, "High and Low Limit Alarms." To disable the high or low limit alarm, set its enable/disable status to OFF.

DO function setting

- Set DO1 and/or DO2 (option) as high and/or low limit alarm outputs, and select the active status, Normal Open or Normal Close. See 8.2.9, "Digital I/O"

■ High and Low Limit Alarm Output Performance

(1) Single range performance

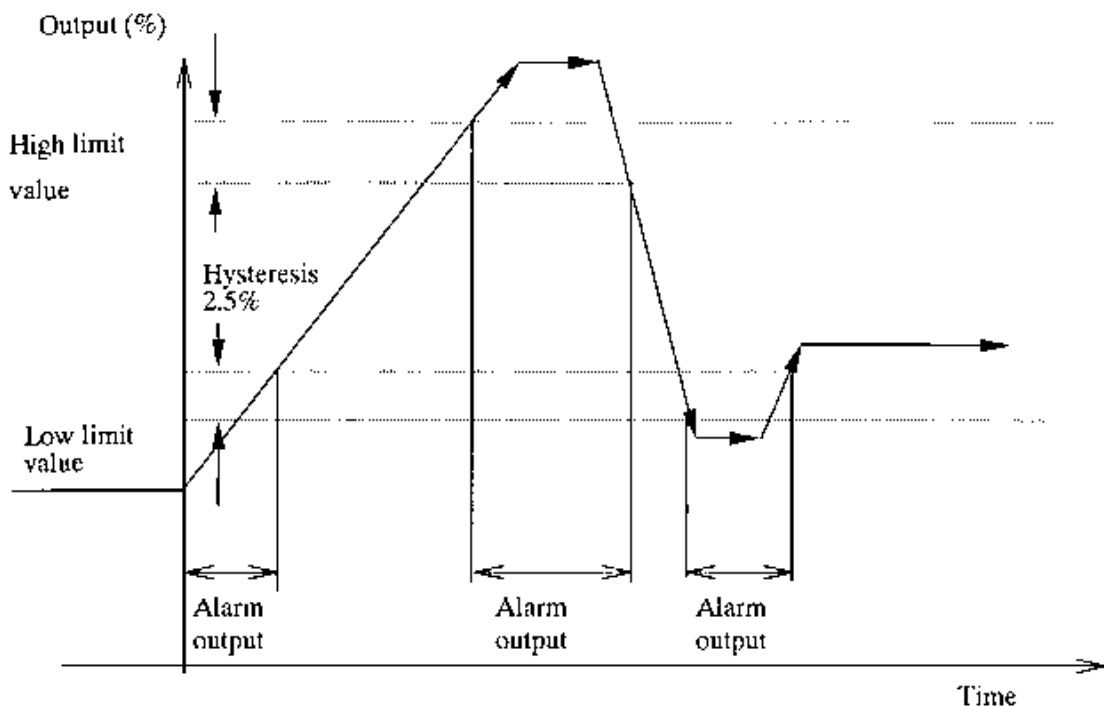

(2) Multi-range performance

In an example shown below, a low limit alarm is set for the Range 2 and a high limit alarm is set for the Range 1.

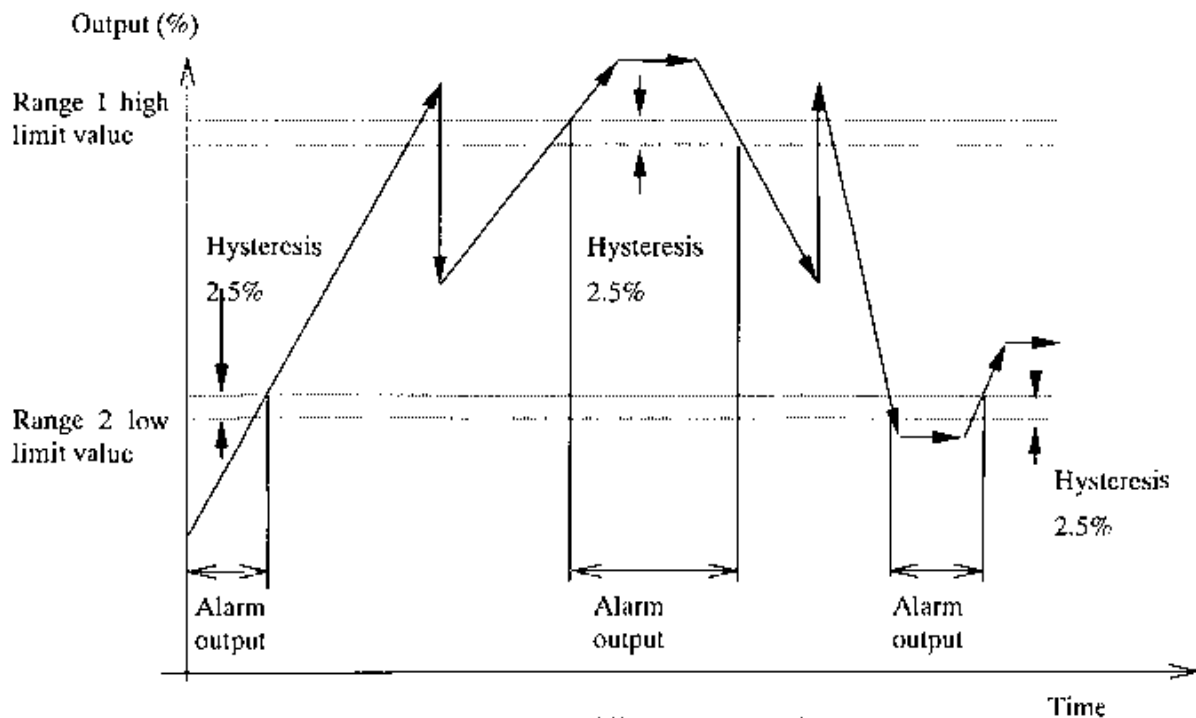

Note: Alarm output contacts are open while the converter is powered off.

10.5 Empty Pipe Alarm

Proceed as follows to use the empty pipe alarm output.

Alarm output setting

- Set the empty alarm enable/disable status to ON. See 8.2.13, "Empty Pipe Alarm."

DO function setting

- Set DO1 or DO2 (option) as the empty pipe alarm output, and select the active status, Normal Open or Normal Close. See 8.2.9, "Digital I/O" If you use the empty pipe alarm function but not an external output, this setting is not needed.

■ Output conditions when an empty pipe alarm occurs:

- 4-20mA output: 4mA .

Note: In case of the converter for special specifications (refer to 7.3.3 "Converter for Special specifications"), select the value which be set 4-20mA Alarm Output.

For detail, see Sec 8.2.18 "4-20mA Alarm Output".

- Totalizer and pulse output: Totalizer and pulse output are stopped.
- Measured data display: Zero is indicated for instantaneous flow rate.
- Alarm output: Condition programmed in the Digital output function and active status set.

Note: Alarm output contacts are open while the converter is powered off.

See Chapter 12, "Self-Diagnostics and Warning Functions." to use the empty pipe alarm function.

10.6 Preset Point Output

Using this preset point output function, you can output a contact signal when the totalized flow reaches its preset value. Proceed as follows to use this function.

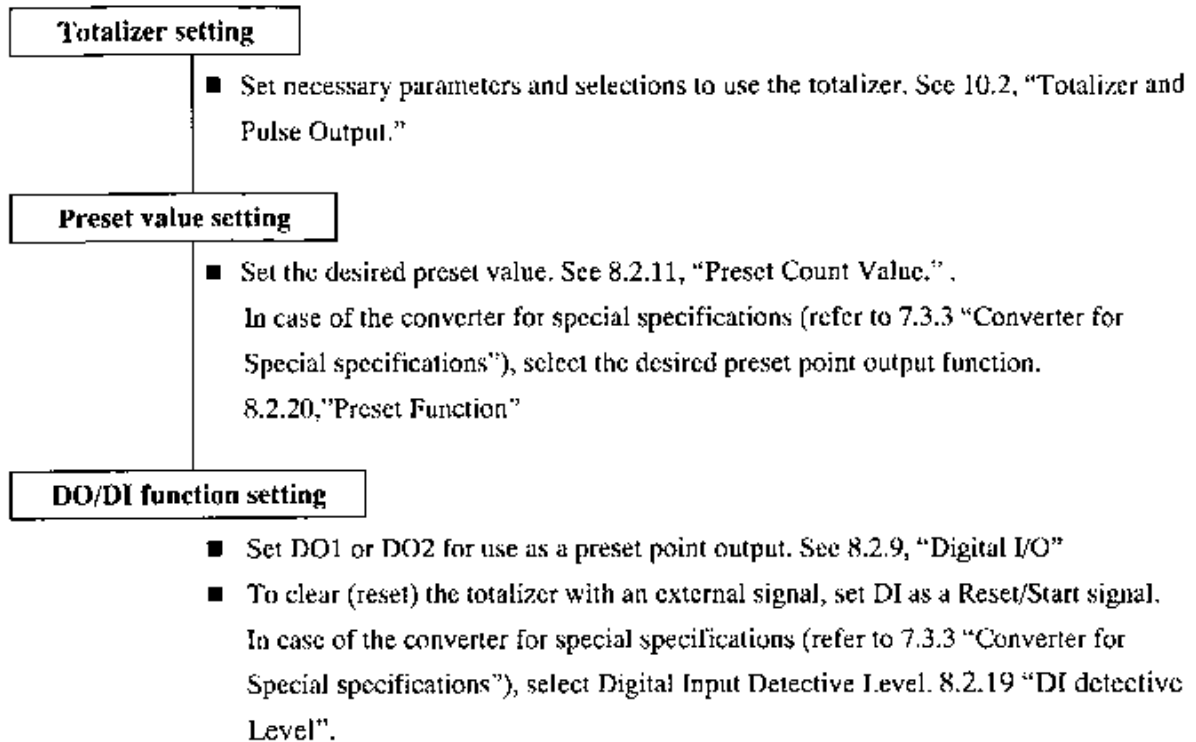

If you use the control keys on the panel (optional) to clear (reset) the totalizer, this setting is not needed.

■ Preset point output performance(1)

The following is an example for preset point output (output status level hold mode) in which the totalizer is reset with an external signal (DI detective level is H).

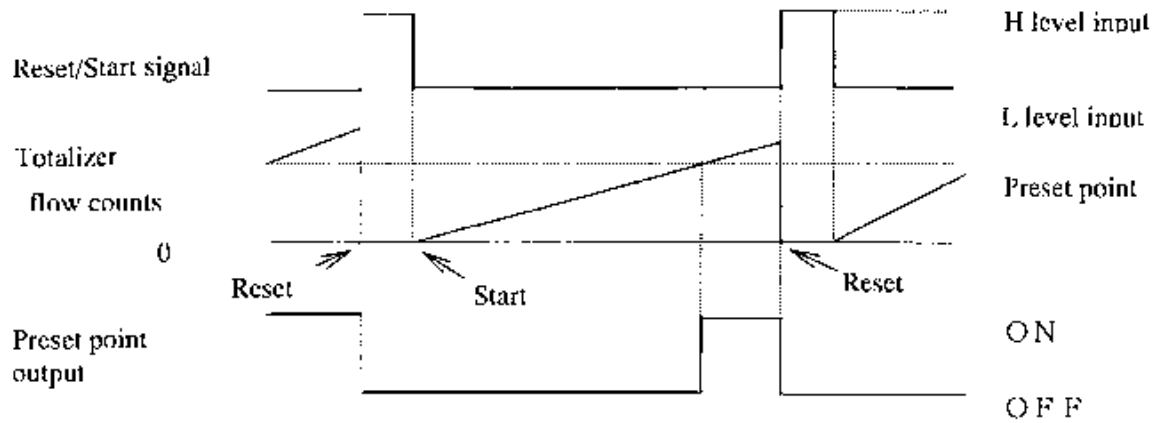

Input/Output signal time chart

- When the Reset/Start signal is in H level, the totalizer is reset to zero and stops counting.
- When the Reset/Start signal goes to L level, the totalizer starts counting.
- The preset point output goes ON when the totalizer counts reaches the preset point , and the output goes OFF when the totalizer is reset to zero.

■ Preset point output performance(2)

The following is an example for preset point output (pulse out mode) in which the totalizer is reset with an external signal (DI detective level is L).

Note: Only In case of the converter for special specifications (refer to 7.3.3 “Converter for Special specifications”), this preset point output (one shot pulse mode) can be selected.

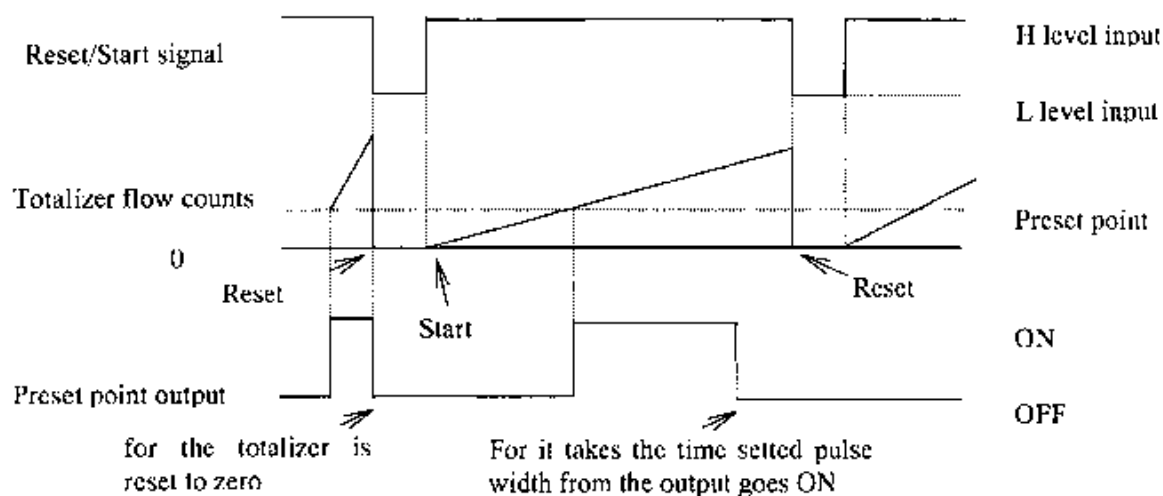

- When the Reset/Start signal is in L level, the totalizer is reset to zero and stops counting.
- When the Reset/Start signal goes to H level, the totalizer starts counting.
- The preset point output goes ON when the totalizer counts reaches the preset point.
- The output goes OFF when the totalizer is reset to zero or when it takes the time setted pulse width from the output goes ON.

■ **Preset point output performance(3)**

The following is an example for preset point output (pulse out mode)

Note: Only In case of the converter for special specifications (refer to 7.3.3 “Converter for Special specifications”), this preset point output (one shot pulse mode) can be selected.

Setting preset count:100

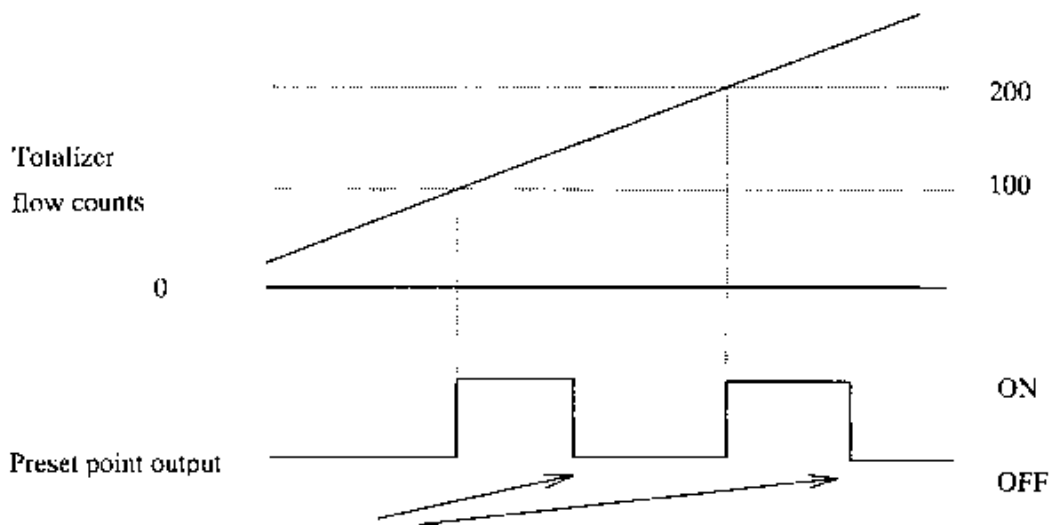

For it takes the time setted pulse width from the output goes ON

- The preset point output goes ON when the totalizer counts reaches the preset point (100 in this example). And the next preset point (200 in this example ; current preset point :100 and preset count :100 makes 200) is setted. In this example repeat this process .
- The output goes OFF when it takes the time setted pulse width from the output goes ON.

NOTE: If preset pulse is setted and preset pulse width is longer than the interval of that totalizer reaches the preset point, the output can't be form pulse out.

If pulse output is needed, set preset count according to shown below.

Preset Pulse Width	The Interval of that Totalizer reaches the Preset Point	Example) Count rate:0.01 l Flow verosity:10 l/s Totalizer count up rate:1ms/COUNT
50ms	More than 100ms	Preset Count:more than 100
500ms	More than 1000ms	Preset Count:more than 1000

10.7 Remote Zero Adjustment

On-stream zero adjustment in a zero flow rate condition can be started with an external signal. To do this, set DI as a zero adjustment start signal. See 8.2.9, "Digital I/O"

■ Start signal requirements:

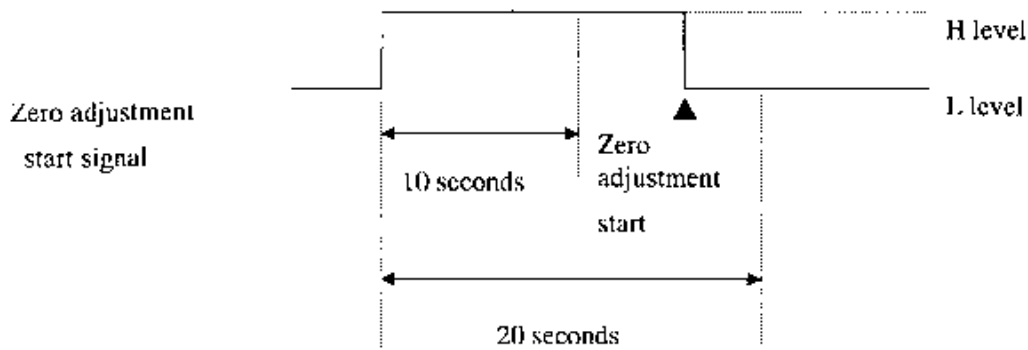

The start signal must be set to H level first, then it must go to L level after the passage of more than 10 seconds but not more than 20 seconds, as shown above. (If the signal does not go to L level within this specified period, it will be ignored.) As soon as the signal goes to L level, zero adjustment sequence starts.

10.8 Remote Selection of Fixed Value Output

A user-specified current output and pulse output can be selected with a DI signal.

Proceed as follows to use this function:

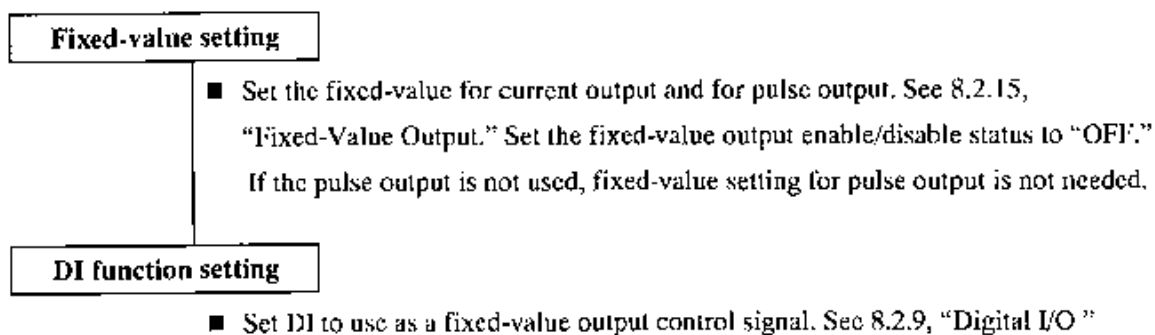

Control signal input conditions:

Control signal input level	4–20 mA and pulse output
L level	Outputs the measured value.
H level	Outputs the fixed-value.

10.9 Converter Failure Alarm

When one or more of the following converter errors occur in a self-diagnostics sequence, an alarm signal can be output. To use this function, set DO1 or DO2 to use as an alarm output signal. See Chapter 12, "Self-Diagnostics and Warning Functions" for details of each alarm status.

■ Self-diagnostics errors

Self-diagnostics error (LCD display)	Error contents
ROM ERROR	ROM error
RAM ERROR	RAM error
PARAMETER FAIL	System parameter error
EX. CURR. OPEN	Excitation circuit open
EX. CURR ERROR	Excitation current error
ADC. ERROR	ADC error
INVALID TOTAL	Invalid totalizer counts

■ Output conditions

Active status of Alarm output can be selected as follows,

- Normal Open; transistor / relay contact is closed when an error occurs.
- Normal Close; transistor/relay contact is open when an error occurs.

Note: Alarm output contacts are open while the converter is powered off.

11. Communications Function

The LF404 converter uses the HART protocol to transmit digital signals over the 4-20mA output line. The AF100 hand-held terminal is used to communicate with the LF404 using the HART protocol. You can check or change configuration parameters, calibrate the flowmeter or monitor the flowmeter measuring value from a remote place.

See the instruction manual for the AF100 hand-held terminal (6F8A0699) for details.

11.1 Connections with the AF100 Terminal

Connect the probe cable of the AF100 terminal in parallel with the load resistance which is wired from the current output terminals (+ and -). Use points such as pins of terminal board or junction terminal to connect with the clip of the probe. See Figure 11.1. To connect the AF100 directly to the flowmeter, use the terminals + and -. See Figure 11.2. These current output terminals are polarized (positive and negative) but you can connect the probe to these terminals without considering their polarity.

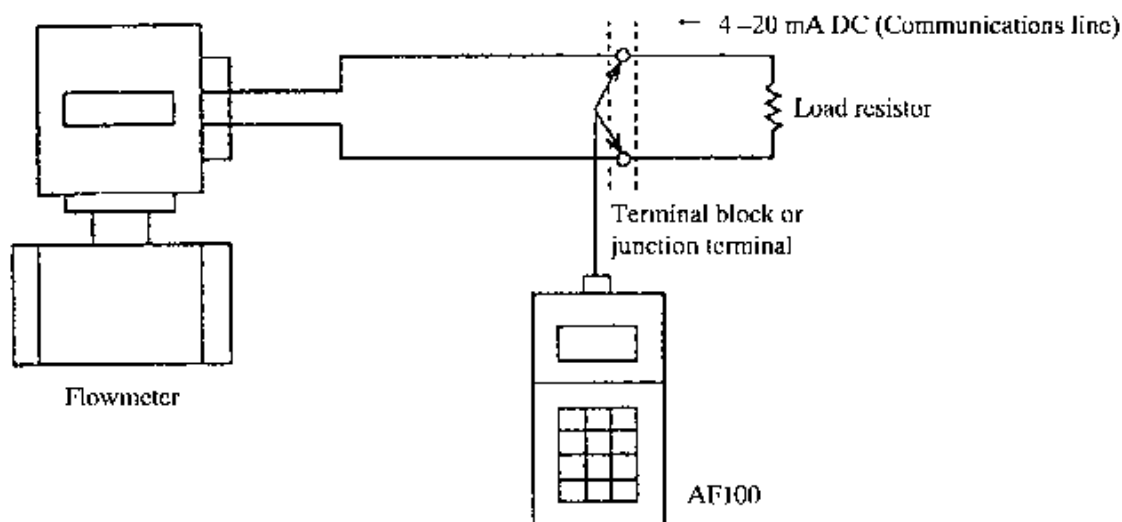

Figure 11.1 Connections to the current output line

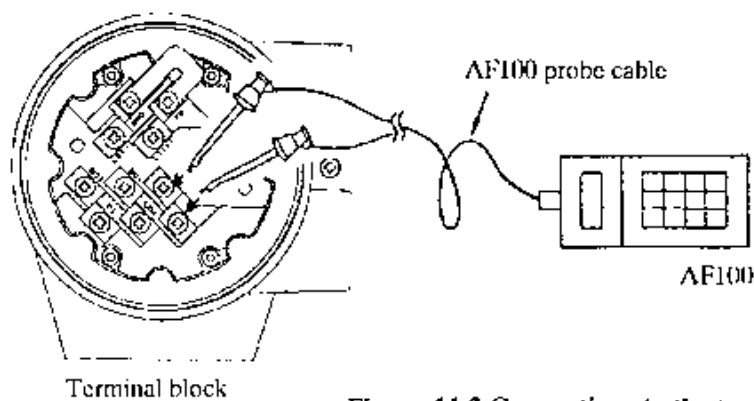

Figure 11.2 Connections to the terminal block

11.2 Communications Procedure

Basic operations of the AF100 terminal are as follows. See the instruction manual of the AF100 terminal for details.

[Procedure]	[Operations]
Communications start	<ul style="list-style-type: none"> ■ Making sure the probe cable of the AF100 is connected to the flowmeter output line, turn on the power of the AF100.
Date and Time setting	<ul style="list-style-type: none"> ■ After the initial display, date and time setting display appears. Enter the current date and time, and press [ENTER]. Press [ENTER] only for date and time not to be changed.
Function menu	<ul style="list-style-type: none"> ■ Function menu appears. Select [F1 : Sensor].
Data transmission	<ul style="list-style-type: none"> ■ Data transmission starts. Various flowmeter data will be transmitted to the AF100.
Write protect/permit	<ul style="list-style-type: none"> ■ Select whether you wish to change/ write data to the flowmeter or simply read data from the flowmeter: <ul style="list-style-type: none"> • Press [YES] and [ENTER] to change/write data; or • Press [NO] and [ENTER] to read data only.
Operation menu	<ul style="list-style-type: none"> ■ Operation menu appears. Select the desired operation item.
Data check/change	<ul style="list-style-type: none"> ■ The data of the selected operation item appears. ■ To change data, press [SET], enter new data, and press [ENTER]. The new data will be transmitted to the flowmeter. Then the new data appears on the AF100. Make sure the data is correct.
Communications end	<ul style="list-style-type: none"> ■ When all the operations are completed, press [ESC] as many times as necessary to return to the operation menu. Then remove the AF100 probe cable from the flowmeter output line and turn off the power of the AF100.

NOTES

1. Pressing [ESC] continuously, the system goes back to "Write protect/permit."
2. Pressing [HOME] continuously, the system goes back to "Function menu."

11.3 Cautionary Notes on Communications

Observe the following notes and limitations when you use the communications function.

■ Current output load

Load resistance: 240 to 1 k Ω (including communications line resistance)

Load capacitance: 0.22 μ F maximum (including communications line capacitance)

Load inductance: 4mH maximum (including communications line inductance)

Cable length: 2 km maximum (approximate value when 1.25 mm² shielded cable is used under standard operating conditions.)

■ Wiring cable

Use a shielded output cable as specified in Table 5.1.

■ Interference on 4-20mA current signal

To communicate with the flowmeter, a digital signal (amplitude 0.4 to 0.8 V in the case of 500 Ω load resistance) with a frequency of 1.2 to 2.2 kHz is superimposed on the 4-20mA current signal. If a high-response receiving instrument is connected to the current output line, the superimposed communications signal may interfere with the instrument. To prevent this interference, put a low-pass filter with a time constant of about 100 ms into the input circuit of the receiving instrument.

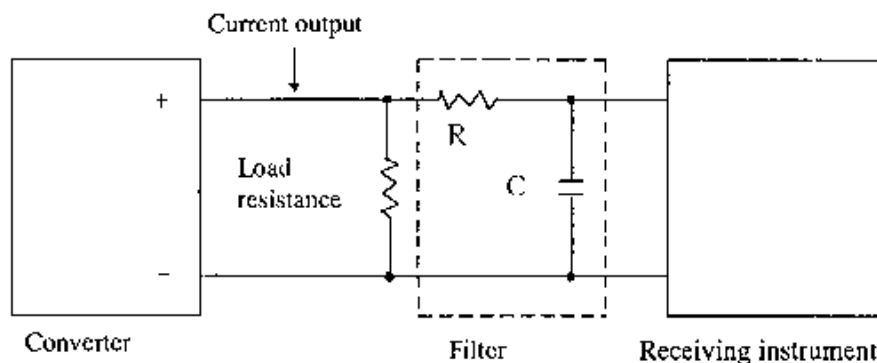

Figure 11.3 Filter connection example

12. Self-Diagnostics and Alarms

Self-diagnostic items and their error or alarm messages are described below.

12.1 Self-diagnostics

The LF404 converter has a self-diagnostics function to detect such problems as setting error, I/O error or converter hardware failure and shows the resulting error or alarm messages on the LCD display (optional) or on the AF100 hand-held terminal through the HART protocol communications. The error or alarm messages and their corrective actions are described below.

■ Setting error

If you try to set the value or measuring unit out of the range specified for each item, one of the following error messages appears.

Error message	Description	Corrective action
* H. OVER SPEC.	Setting value exceeds the allowable high limit.	Try to set the value within the specified range.
* L. OVER SPEC.	Setting value goes below the allowable low limit.	
* H. OVER C RATE	Counting rate exceeds the allowable high limit.	
* L. OVER C RATE	Counting rate goes below the allowable low limit.	
* MULTI RNG ERR	Span is not appropriate for multi-range configuration.	Try to set the span as specified.

■ High and low limit alarms

If the flow rate reading goes out of the set range, one of the following messages appears. If the high or low limit alarm enable/disable status is set to OFF, its alarm function (high or low) is disabled. See 8.2.15, "High and Low Limit Alarms."

Alarm message	Description	Corrective action
H. ALARM	Flow rate reading exceeds the high limit.	Arrange so that the reading stays below the high limit.
L. ALARM	Flow rate reading goes below the low limit.	Arrange so that the reading stays above the low limit.

■ Empty pipe alarm

If the detector pipe is not filled with fluid, the following message appears.

Design piping so that the detector pipe is always filled with the fluid to be measured. If the empty alarm enable/disable status is set to OFF, this function is disabled. See 8.2.13, "Empty Pipe Alarms."

Alarm message	Description	Corrective action
EMPTY	Detector pipe is not filled with fluid.	Arrange piping so that the detector pipe is always filled with fluid.

Precautionary notes on using the empty pipe alarm

- (1) The flowmeter detects an empty pipe condition by monitoring the impedance and signal level between the flow signal lines connected to a pair of electrodes. Therefore, the following factors may trigger an erroneous empty pipe alarm:
 - Opening or loose connection of flow signal lines
 - The fluid to be measured carrying a lot of bubbles
 - Contamination of the electrode with non-conductive deposits
- (2) If the flowmeter is not grounded properly or if it is in an environment where high electrical noise exists, the empty pipe alarm may not function properly. Under these conditions, the reliability of flowmeter accuracy itself is not high. Try to ground the flowmeter securely to an independent good ground and relocate the cable runs to prevent noise from entering into the flowmeter circuit.
- (3) If the fluid still remains in the detector pipe or the internal wall of the detector pipe is contaminated with electrically conductive deposits, the impedance between the signal lines will not go high and the empty pipe alarm may not work. In this kind of event, try to use other means to detect an empty pipe condition (such as a pump stop signal or a signal from a valve).

■ Converter hardware failure

The system checks the internal circuitry at the time of power-up for all error items and checks continuously for the specified items as described below. If an error is detected, one of the messages shown in the table below will be displayed.

If multiple errors occur, their messages will be displayed cyclically. The diagnostics items concerning the excitation cable and excitation circuit are detected using the ADC circuit. Thus, if the ADC fails, No. 4 (excitation cable) and No. 5 (excitation circuit) errors can not be detected correctly. Further, this entire checking system is based on the CPU in the flowmeter. Therefore, if the CPU fails, no accurate diagnostics or error message display can be obtained.

No.	Error message	Description	Corrective action
1	* ROM ERROR *	ROM error	Internal components or printed-circuit board must be repaired or replaced. Contact your nearest Toshiba representative.
2	* RAM ERROR *	RAM error	
3	PARAMETER FAIL	System parameter error	
4	EX. CURR. OPEN	Excitation cables are not connected.	Connect the excitation cables correctly.
5	EX. CURR. ERROR	An error occurred in the excitation circuit.	Internal components or printed-circuit board must be repaired or replaced. Contact your nearest Toshiba representative.
6	ADC. ERROR	ADC error	
7	INVALID TOTAL	Totalizer data was destroyed due to external noise. (No message appears if totalization is not used.)	The error message disappears if you press the reset key.

NOTES

- Errors No. 1 to No. 3 can be detected only at the time of power-up. The flowmeter does not start measurement if any one of these errors is detected. If these errors occur after power-up, the flowmeter cannot detect these errors, and thus may indicate and output incorrect data.
- Errors No. 4 to No. 6 may not be detected even if the errors result in incorrect flowmeter accuracy, because of characteristic differences in components used to detect these errors.
- CPU error cannot be detected. If the CPU stops, the watchdog timer resets the internal circuits and the flowmeter starts again from the initial power-up condition. Depending on CPU condition, the flowmeter may not indicate and output correct data.

12.2 Output Status for Errors and Alarms

The flowmeter data display, current and pulse outputs will become as follows if an error or alarm occurs.







Error or alarm message	Data display	Current output (4-20mA)	Totalizer and pulse output	Remarks
ROM ERROR (Note 1)	—	4mA (Note 3)	Stopped	After power-up, no measurement starts.
RAM ERROR	—		Stopped	
PARAMETER FAIL (Note 2)	Zero		Stopped	—
EX. CURR OPEN	Zero		Stopped	Zero adjustment (on-stream at zero flow rate) cannot be conducted.
EX. CURR ERROR	Zero		Stopped	—
ADC. ERROR	Zero		Stopped	—
EMPTY	Zero		Stopped	Zero adjustment (on-stream at zero flow rate) cannot be conducted.
INVALID TOTAL	Measured data	Measured data	Measured data	The error message disappears if you clear (reset) the totalizer.
H.ALARM	Measured data	Measured data	Measured data	—
L.ALARM	Measured data	Measured data	Measured data	—



Notes

1. The display and output may not be as indicated depending on the nature of the ROM error.
2. If parameters related to the current output are defective, the current output may not be exactly 4mA.
3. In case of the converter for special specifications (refer to 7.3.3 "Converter for Special specifications"), select the value which be set 4-20mA Alarm Output. For detail, see See 8.2.18"4-20mA Alarm Output".

13. Maintenance and Troubleshooting

Safety precaution for Maintenance and Troubleshooting

 WARNING	
<p>■ Do not disconnect while circuit is live unless location is known to be non-hazardous.</p> <p> DON'T</p>	<p>Live part of electric circuit or a high temperature department can cause explosion.</p>
<p>■ Do not modify or disassemble the enclosure.</p> <p> DON'T</p>	<p>Strength degradation and defects of enclosure can cause explosion.</p>
<p>■ Do not use parts of other products.</p> <p> DON'T</p>	<p>Protective performance degradation for hazardous location can cause explosion.</p>
<p>■ Do not live circuits While assembly of all component is not over.</p> <p> DON'T</p>	<p>Protective performance degradation for hazardous location can cause explosion.</p>
<p>■ Install per the National Electrical Code for the US (NEC, ANSI/NFPA 70) and the Canadian Electrical code for Canada (CEC, CAN/CSA-C22.1).</p> <p> DO</p>	<p>Unsuitable conduit connections for hazardous location can cause explosion.</p>

 CAUTION	
<p>■ Do not conduct wiring work when power is applied.</p> <p> DON'T</p>	<p>Wiring while power is applied can cause electric shock.</p>
<p>■ Do not touch the LF434/LF404 main body when high temperature fluid is being measured.</p> <p> DON'T</p>	<p>The fluid raises the main body temperature and can cause burns.</p>

13.1 Maintenance

■ Calibration

The LF404 converter has a reference signal generating circuit. This reference signal can be used to check the zero and span of the converter for the purpose of instrumentation maintenance or periodical inspection. See Chapter 9, "Calibration."

■ Fuse

The fuse can be taken out by unscrewing the cap of the fuse holder. Check that the fuse is not damaged. The fuse has to be replaced periodically. The recommended replacement period is 3 years.

Type of fuse used:	Glass tube fuse (normal blow type)	1 piece
Rating:	1A, 250 V for 100 to 240 V ac or 110 V dc power supply	
	2A, 250 V for 24 V dc power supply	
Dimensions:	Diameter 5.2 mm × 20 mm	

■ LCD display (optional)

If the characters displayed on the LCD are dimmed or blurred, the LCD display should be replaced. To extend the life of the flowmeter, replace the LCD early. To check and replace the LCD display, contact your nearest Toshiba representative.

■ Power supply unit

Electronic components deteriorate faster when the ambient temperature is high. The life of the power supply unit in the converter is 9 to 10 years if the ambient temperature is 40° C, and 5 to 6 years if it is 50° C. To extend the life of the flowmeter, we recommend you replace the power supply unit early. Contact your nearest Toshiba representative for a flowmeter inspection or unit replacement.

IMPORTANT

- (1) It is recommended that the detector pipe be cleaned once a year.
- (2) Use always new packing when mounting the flowmeter detector in the pipeline.

■ Cleaning the pipe wall inside of detector

If the fluid to be measured contains slurry; a high concentration of electrically conductive solids, the slurry may accumulate as sticking on the pipe wall inside of detector.

The sticking causes a reduction of flow measuring outputs when it is not cleaned inside pipe of detector for a long time.

The flowmeter needs to make sure it remains around the wall inside pipe or not when the following condition had happened.

- (1) The flowmeter becomes a reduction of its output.
- (2) The flowmeter can not improve its output in spite of being calibrated.

The flowmeter is required to remove along with clean it using a soft brush. It will be come back the usual and stable flow measurement after cleaning.

The pipe wall is never scratched when cleaning.

*Toshiba recommends to clean inside pipe periodically when this condition will become easily.

*It is better to choose the suitable diameter which becomes more than 3 m/s as its flow velocity to avoid this condition generally.

*If uninstall the flowmeter(detector) from the pipe flange, necessarily install new packings.

Notes: Before uninstalling the flowmeter(detector) from the pipe flange, necessarily confirm the fluid of temperature and chemical property, and empty the fluid from detector.

Prepare the way to protect operator and system from bad influence; high temperature fluid and chemical property

■ Operative life

The operative life of this flowmeter is 10 years from the date of shipment. The life of the flowmeter differs depending on the environmental conditions and the way it was used. To extend the life of the flowmeter, inspect the flowmeter periodically and clean or replace components if necessary.

13.2 Troubleshooting

If a problem occurs while using the LF434/LF404, follow the flowcharts described below. You may find a way to solve the problem. The flowcharts are based on three symptoms (1) to (3). If you cannot solve the problem, contact your nearest Toshiba representative.

(1) Flow rate is not indicated.

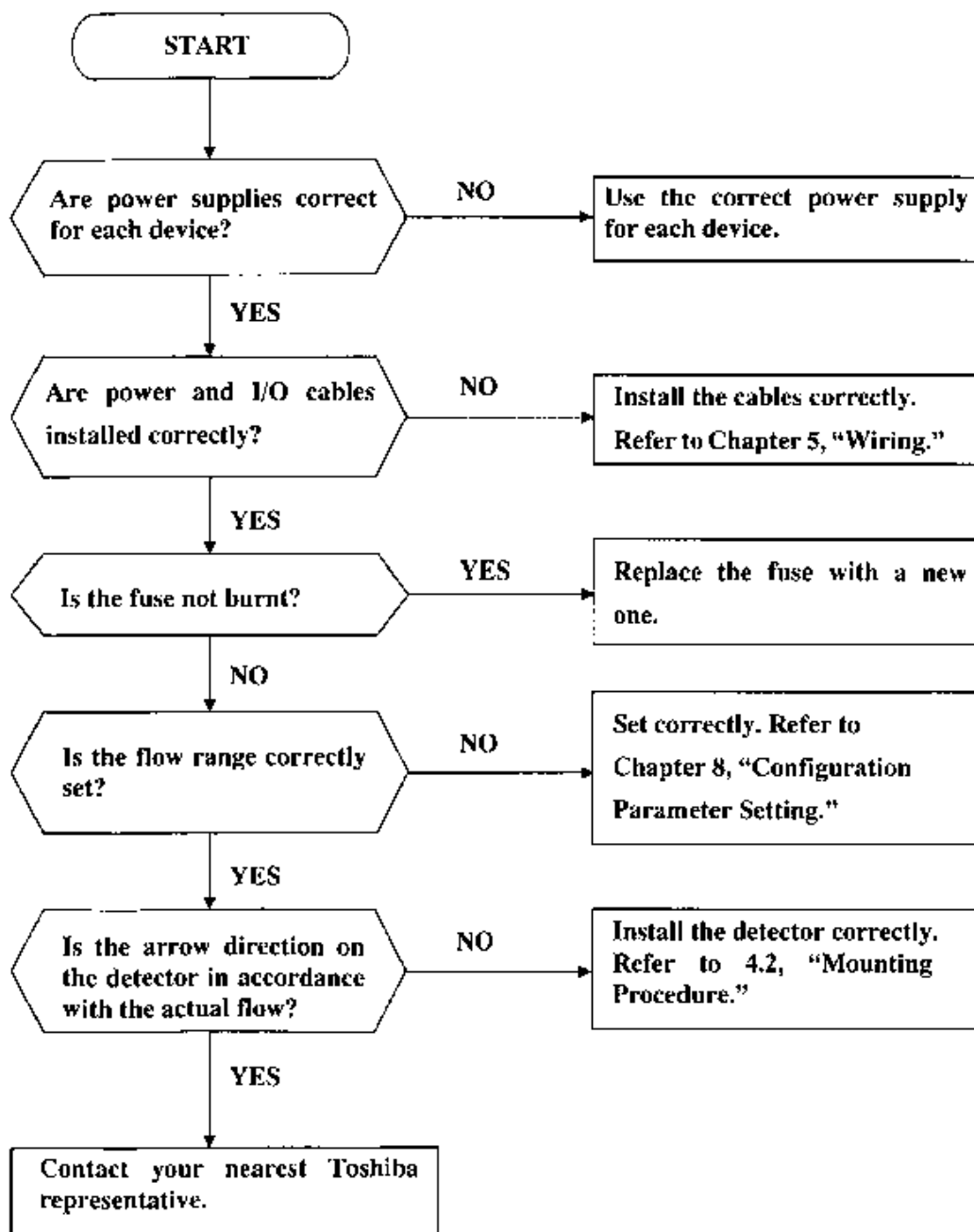

(2) Flow rate indication is not correct.

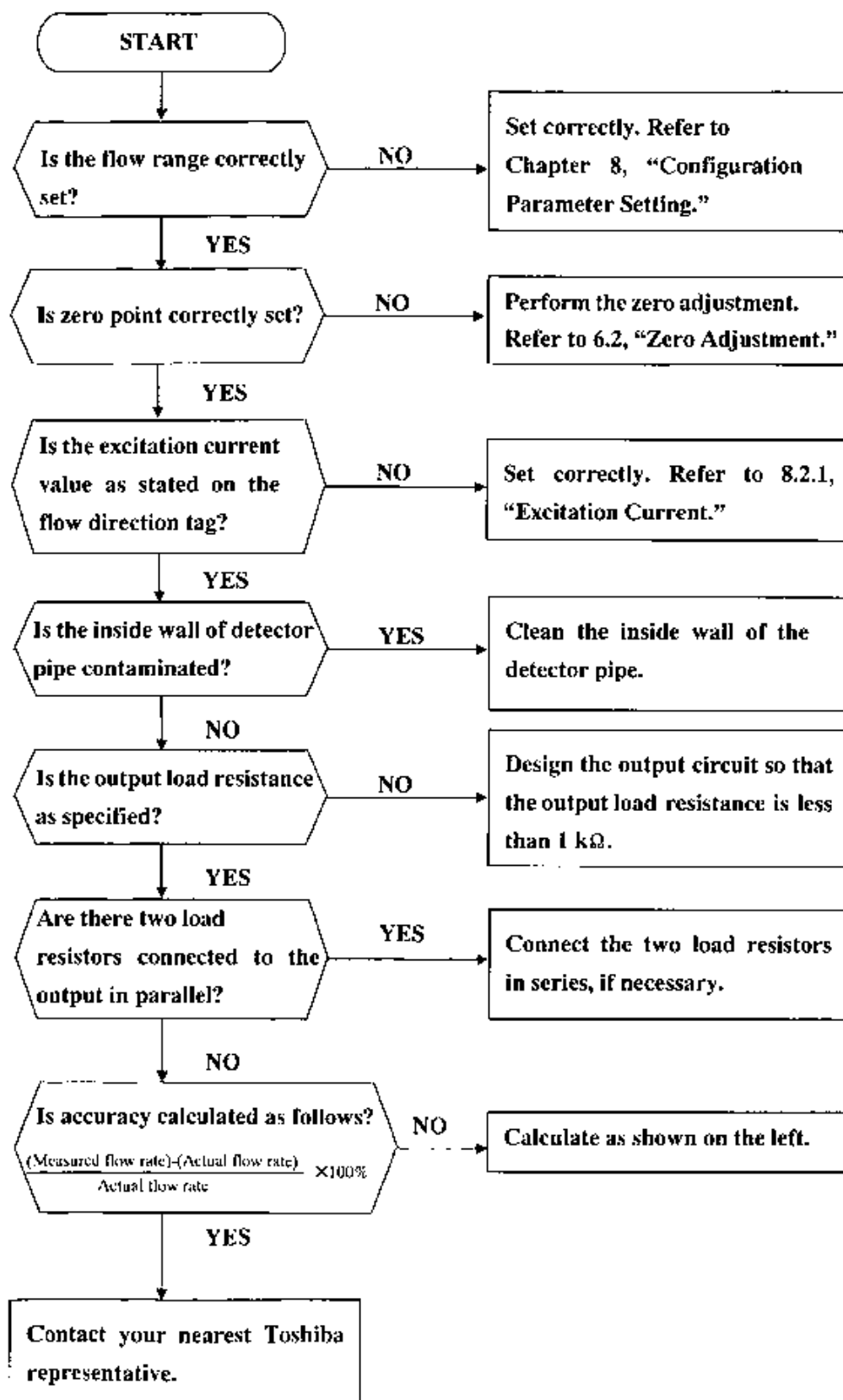

(3) Flow rate indication is not stable.

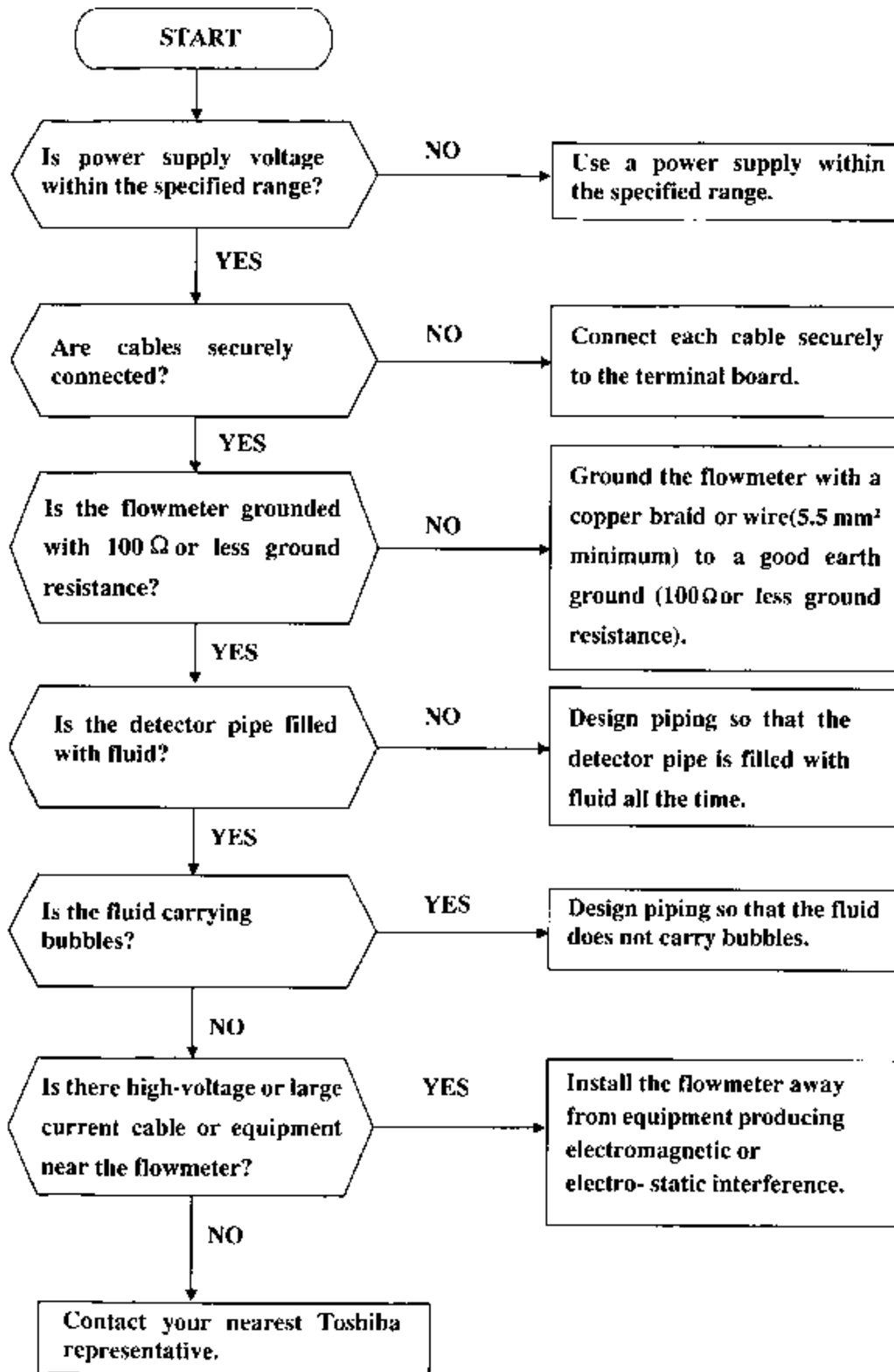

14. Principle of Operation

The operating principle of the electromagnetic flowmeter is based on Faraday's Law of electromagnetic induction and it is designed to measure the volumetric flow rate of fluid. An insulated pipe of diameter D is placed vertically to the direction of a magnetic field with flux density B (see Figure 14.1). When an electrically conductive fluid flows in the pipe, an electrode voltage E is induced between a pair of electrodes placed at right angles to the direction of magnetic field. The electrode voltage E is directly proportional to the average fluid velocity V.

The following expression is applicable to the voltage.

$$E = K \times B \times D \times V \text{ [V] (Eq. 14.1)}$$

- E = induced electrode voltage [V]
- K = constant
- B = magnetic flux density [T]
- D = meter pipe diameter [m]
- V = fluid velocity [m/s]

Volumetric flow rate Q [m³/s] is:

$$Q = \frac{\pi \times D^2}{4} \times V \text{(Eq. 14.2)}$$

Using the Equation 14.1 and 14.2

$$E = K \times B \times D \times \frac{4}{\pi \times D^2} \times Q$$

$$E = \frac{4 \times K \times B}{\pi \times D} \times Q \text{(Eq. 14.3)}$$

Therefore, volumetric flow rate is directly proportional to the induced voltage.

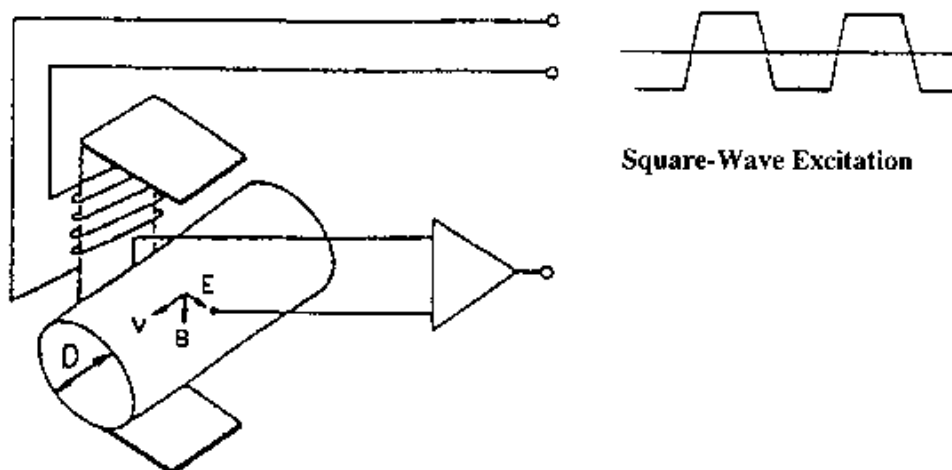

Figure 14.1 Principle of Operation

The LF434/LF404 electromagnetic flowmeter uses the square-wave excitation method, which provides long-term stable operation. With square-wave excitation, the LF434/LF404 offers reliable measurement without being affected by electrostatic or electromagnetic interference, or electrochemical polarization between the electrodes and the fluid to be measured.

15. Specifications

The flowmeter specifications and the type specification code used when ordering the flowmeter are described in this chapter.

15.1 Flowmeter Specifications

■ Overall Specifications

Measurement range in terms of flow velocity:

0–0.3 m/s to 0–10 m/s (0–0.1 m/s to 0–0.3 m/s range is available optionally)

System accuracy: See the following table.

Table 15.1 System accuracy

Flow rate as a percentage of range	Accuracy		
	0.1–1.0 m/s	0.3 – 1.0 m/s	1.0–10 m/s
0 to 20%	_____	_____	±0.1% FS
20 to 100%	_____	_____	±0.5% of rate
0 to 50%	±0.25% of FS	_____	_____
50 to 100%	±0.5% of rate	_____	_____

Note: The accuracy above is measured under standard operating conditions at Toshiba's calibration facility.

Dimensions and Mass: See Chapter 16, "Outline Dimensions."

■ LF434 Detector

Meter size: 15, 25, 40, 50, 80, 100, 150, 200, 250, 300, 350 and 400 mm

Fluid pressure: -0.1 MPa to the pressure limited by the connection flange

Connection flange standard: See Table 15.2 Type Specification Code.

Fluid conductivity: 5 μ S/cm minimum

Fluid temperature: -10 to +80 °C (EPDM rubber Lining detector)

-10 to +120 °C (Teflon PFA Lining detector)

Ambient temperature: -10 to +60 °C

Dimensions and Mass: See Chapter 16, "Outline Dimensions."

Principal materials

Case * * * * Carbon steel

Measuring tube * * * 304 stainless steel

Lining * * * EPDM rubber (standard for meter sizes 80 to 400 mm)

Teflon PFA (standard for meter sizes 15 to 50mm)

Electrodes * * * 316L stainless steel (standard)

Grounding rings * * * 304 stainless steel (standard)

See Table 15.2 Type Specification Code for optional materials and other related information.

Structure: IP67 (NEMA 4X) Watertight

Coating: Phthalic acid resin coating, pearl-gray colored

■ LF404 Converter**Input signal****Digital input DI (option)****Signal type:** 20 to 30 V dc voltage signal**Input resistance:** 2.7 k Ω **Number of inputs:** One point**Output signals****Current output:** 4 to 20 mA dc (load resistance 0 to 1 k Ω)**Digital outputs** — One point (standard). One more point is optionally available.**Digital output DO1 (standard):****Output type:** Transistor open collector**Number of outputs:** One point**Output capacity:** 30 V dc, 200 mA maximum**Digital output DO2 (option):****Output type:** Solidstate relay (non polarity)**Number of outputs:** One point**Output capacity:** 50 V dc, 150 mA maximum**DI function** — One of the following functions can be assigned for the optional DI signal.**Range switching** — Selects one of two ranges in the 2-range setting or selects either the higher or lower range in the bidirectional 2-range setting.**Totalizer control** — "Starts and stops" or "Resets and Starts" the totalizer.**Fixed-value outputs** — Outputs fixed-values for current output and pulse output.**Zero adjustment** — Starts zero adjustment (on-stream at zero flow rate).

DO1 and DO2 functions — One of the following functions can be assigned for DO1 (standard) and/or DO2 (option).

- **Pulse output (available only for DO1)**
 Pulse rate: 3.6 to 3600000 pulses/hour
 Pulse width: 0.5 to 500 ms (but less than half of the period of pulse output for 100% flow rate)
- **Multi-range selection outputs**
 One output used: (1) 2-range switching for unidirectional flow
 (DO1 or DO2) (2) Forward/Reverse flow range switching
 Two outputs used: (1) 4-range switching for unidirectional flow
 (DO1 and DO2) (2) 2-range switching for Forward and Reverse flows
- **High and/or low limit alarms outputs**
 Outputs an alarm signal if the process flow rate goes above or below the set limits. Output status is programmable.
 Setting range: -10 to 110% of the span (range)
 Output status: Normal Open or Normal Close selected
- **Empty pipe alarm output**
 Outputs an alarm signal when the detector pipe is not filled with fluid.
 Output status: Normal Open or Normal Close selected
- **Preset point output**
 Outputs a signal when the totalized flow reaches the preset value.
 Setting range: 1 to 99999999 counts
 Output status: Contact ON (closed)
- **Converter failure alarm**
 Outputs a signal if an error occurs when self-diagnostics is conducted.
 Output status: Normal Open or Normal Close selected

Communications output

a small digital signal is superimposed on 4-20 mA current signal (conformed to HART protocol)

- Load resistance:** 240 to 1 k Ω
- Load capacitance:** 0.25 μ F maximum
- Load inductance:** 4mH maximum
- Cable length:** 2km maximum (approximate value when 1.25mm² shielded cable is used under standard operating condition)

Note: HART (Highway Addressable Remote Transducer) is a communications protocol for industrial sensors recommended by ICF (HART Communication Foundation).

Damping: 0.5 to 60 seconds (selectable in increments of 1 second)

Parameter setting — Parameters can be set as follows depending on whether the LCD display is provided or not.

LF404 with LCD display: Three control keys are provided to set configuration parameters.

LF404 without LCD display: The AF100 hand-held terminal is needed to set parameters.

Zero and span calibration:

Built-in calibration signal source allows converter unit check.

Zero adjustment:

Zero point adjustment can be started by pressing the switch in the converter.

Conditions when power fails:

The outputs and display will become as follows when power fails. Parameter setting values are stored in non-volatile memory and the values will be restored when the power returns to normal condition.

Current output: 0 mA dc

Digital output: OFF (Open)

LCD display: No display

Power supply:

One of the following can be selected:

- 100 to 240 V ac (Allowable voltage 80 to 264 V ac), 50/60 Hz (standard) .
- 24 V dc (Allowable voltage 20.4 to 28.8 V dc)
- 110 V dc (Allowable voltage 98 to 121 V dc)

Arrester:

Arresters are installed in the power supply and current signal output circuit.

To use the arresters, ground the GND terminal. (See Chapter 5, "Wiring.")

Housing: Aluminum alloy

Coating: Acrylic resin-baked coating, pearl-gray colored

Structure: IP67 (NEMA 4) Watertight

Cable connection port: 1/2-14 NPT thread

Vibration resistance

No resonance to the following levels of vibration:

- 10 to 60 Hz, amplitude 0.07 mm;
- 60 to 150 Hz with acceleration of 9.8 m/s².

No problem occurs after application of 30 Hz, 29.4 m/s vibration in any axis for four 4 hours.

Note: Avoid using the flowmeter in an environment with constant vibration.

Table 15.3 Type Specification Code (Model LF404 Converter)

Specification Code														Specification Code	
1	2	3	4	5	6	7	8	9	10	11	12	13	14		
L	F	4													Electromagnetic Flowmeter
			0												Shape Round
			4												Area of use Division 2 Hazardous Location
				F											Usage FM Approval CSA Approval
				G											Mounting Structure Detector/Converter combined type
					A										Display not provided (standard) LCD display provided
					B										Output 4-20 mAdc output and pulse output (standard) with digital I/O provided
								1							Communications function provided (HART protocol)
								2							Power supply 100 to 240 Vac, 50/60 Hz 24 Vdc 110 Vdc
									1						Coating Acrylic resin-baked coating, pearl-gray colored
												A			Standard
													B		

16. Outline Dimensions

■ Meter size 15 to 150mm

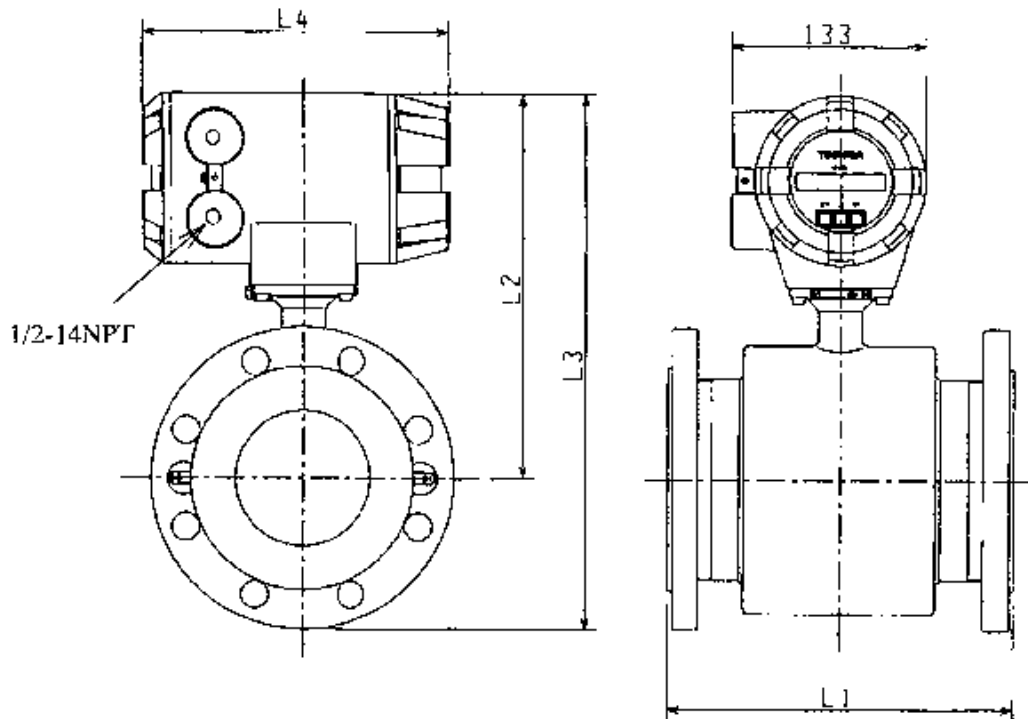

Display	Dimensions L4	
	L4	
	(mm)	(inch)
not provided	192	7.56
provided	216	8.50

Meter size		L1		L2		L3				Weight			
						BS10 DIN10 (mm)	BS16 DIN16 (mm)	ANSI 150 (inch)	ANSI 300 (inch)	BS10 DIN10 (kgf)	BS16 DIN16 (kgf)	ANSI 150 (lb)	ANSI 300 (lb)
mm	inch	mm	inch	mm	inch								
15	1/2	140	5.51	214	8.43	261.50	261.50	10.18	10.30	6	6	13	14
25	1	160	6.30	217	8.54	274.50	274.50	10.67	10.98	9	9	19	21
40	1 1/2	170	6.69	226	8.90	301.00	301.00	11.40	11.96	12	12	24	29
50	2	180	7.09	234	9.21	316.50	316.50	12.21	12.46	14	14	31	35
80	3	230	9.06	249	9.80	349.00	349.00	13.55	13.93	20	20	47	57
100	4	240	9.45	267	10.51	377.00	377.00	15.01	15.51	24	24	61	83
150	6	260	10.24	297	11.69	439.50	439.50	17.19	17.94	28	28	89	136

■ Meter size 200mm

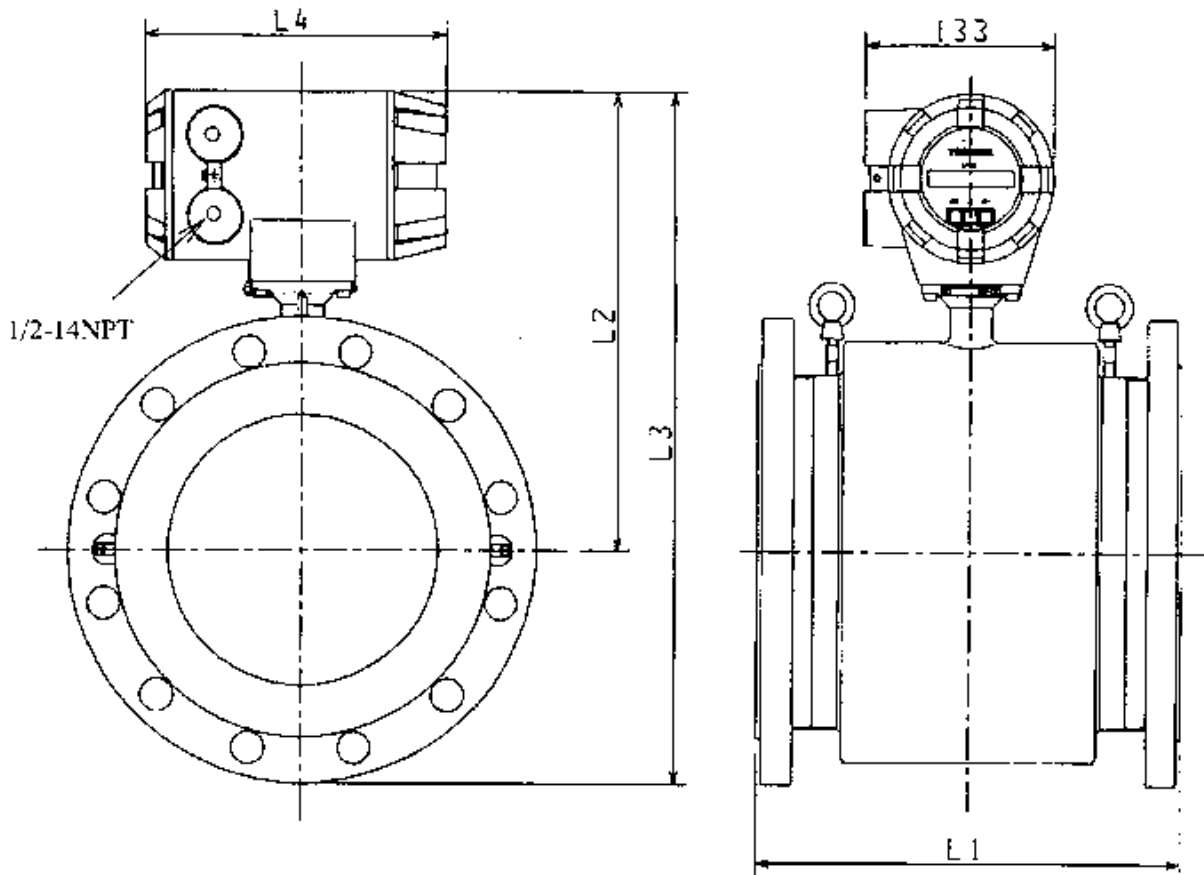

Display	Dimensions L4	
	L4	
	(mm)	(inch)
not provided	192	7.56
provided	216	8.50

Meter size		L1		L2		L3				Weight			
						BS10 DIN10 (mm)	BS16 DIN16 (mm)	ANSI 150 (inch)	ANSI 300 (inch)	BS10 DIN10 (kgf)	BS16 DIN16 (kgf)	ANSI 150 (lb)	ANSI 300 (lb)
mm	inch	mm	inch	mm	inch	(mm)	(mm)	(inch)	(inch)	(kgf)	(kgf)	(lb)	(lb)
200	8	300	11.81	323	12.72	493	493	19.47	20.22	55	55	136	208

■ Meter sizes 250 to 400 mm

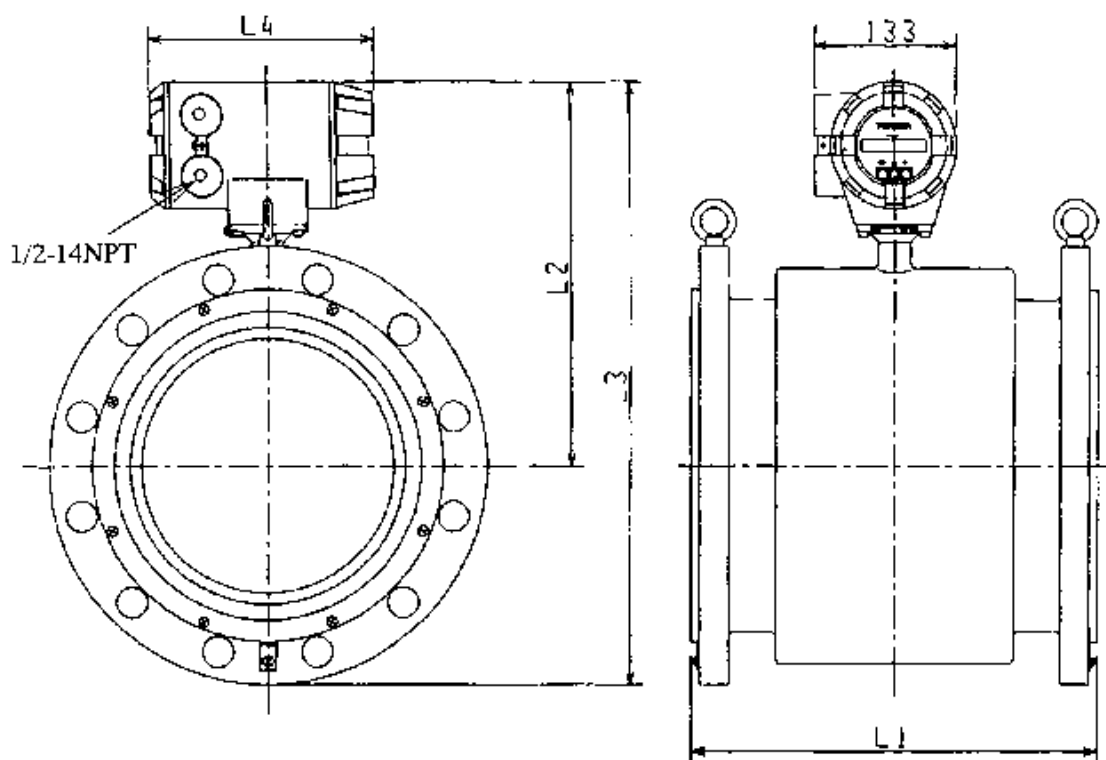

Display	Dimensions L4	
	L4	
	(mm)	(inch)
not provided	192	7.56
provided	216	8.50

Meter size		L1		L2		L3				Weight			
						BS10 DIN10 (mm)	BS16 DIN16 (mm)	ANSI 150 (inch)	ANSI 300 (inch)	BS10 DIN10 (kgf)	BS16 DIN16 (kgf)	ANSI 150 (lb)	ANSI 300 (lb)
mm	inch	mm	inch	mm	inch	(mm)	(mm)	(inch)	(inch)	(kgf)	(kgf)	(lb)	(lb)
250	10	350	13.78	346	13.62	543.50	548.50	21.62	22.37	79	81	200	320
300	12	400	15.75	373	14.69	595.50	603.00	24.19	24.94	105	114	293	466
350	14	450	17.72	390	15.35	642.50	650.00	25.85	26.85	149	161	409	634
400	16	500	19.69	411	16.18	693.50	701.00	27.93	28.93	185	191	487	783

Appendix 1**Electromagnetic Compatibility and Low Voltage Safety**

Electromagnetic Flowmeter LF434/LF404 has been confirmed to comply with the requirements of the EMC directive 89/336/EEC and the low voltage directive 93/68/EEC.

EMC directive

This device has been tested in a typical configuration in accordance with the following standards in an industrial environment.

• Generic emission standard	EN50081-2
Conducted RF emissions	EN55011
Radiated RF emissions	EN55011
• Generic immunity standard	EN50082-2
Conducted RF immunity	ENV50141
Radiated RF immunity	ENV50140/ENV50204
Electrostatic discharge	EN61000-4-2
Fast transient burst	EN61000-4-4

The above EMC tests have been carried out with the flowmeter installed properly in accordance with this instruction manual. However, there is no guarantee that interference will not occur in a particular installation.

To reduce interference to or from other equipment, please check the following installation points.

- (1) Use shielded cables for all I/O cables. When the flowmeter is the separated type, the signal cable and excitation cable for the connection between the detector and the converter are supplied by Toshiba. To improve immunity, pass each cable through a thick steel conduit tube.
- (2) If this device is installed in an area where RFI exists, deviation of the current output signal may be caused. In this case, ferrite cores will be required on each I/O cable. Please contact Toshiba or the agency if required.
- (3) This device is designed to be used in an industrial environment and may cause reception interference to radio, television or wireless communications. In this case, relocate the receiving antenna.
- (4) The use of a transceiver or wireless equipment near this device may cause interference to the accurate measurement. If deviation of the output signal appears during use of a radio, increase the distance between the converter or the signal cable and the antenna.

Low voltage directive

- Low voltage standards EN61010-1

Environmental conditions:

Installation category II

Pollution degree 2

Altitude Up to 2000 m

Other conditions are specified in Chapter 15, "Specifications."

USER'S FORM
NOTES

Unit purchased from	
Name
Title
Company
Address
City/State or Province
Country
Tel
Fax
Model/Specification Code	LF434/LF404
Serial No.

Industrial Equipment Department
1-1, Shibaura 1-chome, Minato-ku, Tokyo, 105, Japan
Tel.: +81-3-3457-4900 Fax.: +81-3-5444-9268



TOSHIBA CORPORATION
